

| | |
|--|--|
| <p>Dichtungen die so oder ähnlich aussehen finden Sie auf:</p> <p>Seite 1 bis 6</p> |  |
| <p>Dichtungen die so oder ähnlich aussehen finden Sie auf:</p> <p>Seite 10 bis 12</p> |  |
| <p>Dichtungen die so oder ähnlich aussehen finden Sie auf:</p> <p>Seite 15 bis 16</p> |  |
| <p>Dichtungen die so oder ähnlich aussehen finden Sie auf:</p> <p>Seite 20</p> |  |

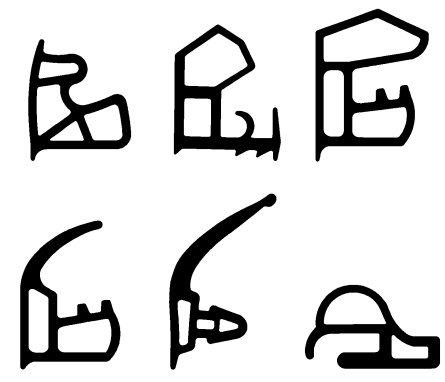

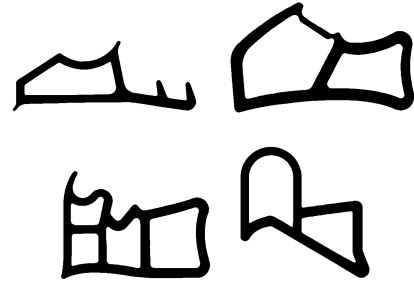
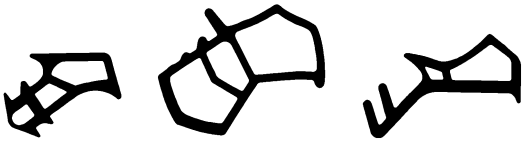
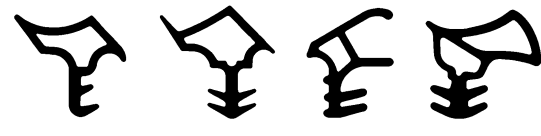
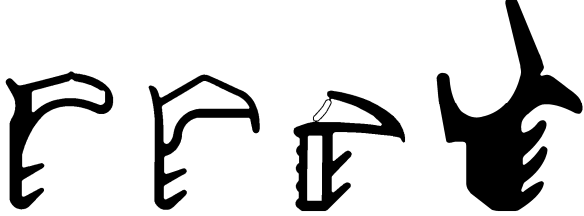
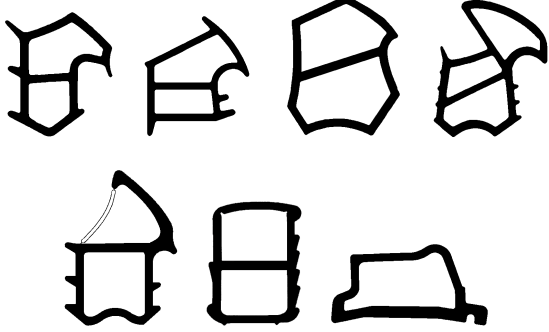
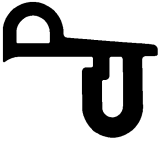
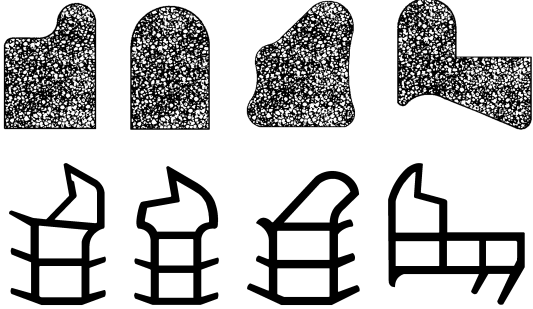
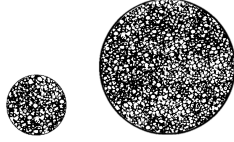
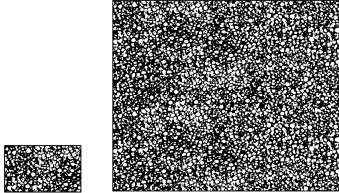
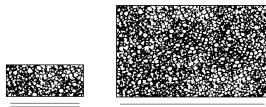

Stand 07/24

| | |
|--|---|
| <p>Dichtungen die so oder ähnlich aussehen finden Sie auf:</p> <p>Seite 22</p> |  |
| <p>Dichtungen die so oder ähnlich aussehen finden Sie auf:</p> <p>Seite 25 bis 33</p> |  |
| <p>Dichtungen die so oder ähnlich aussehen finden Sie auf:</p> <p>Seite 40</p> |  |
| <p>Dichtungen die so oder ähnlich aussehen finden Sie auf:</p> <p>Seite 45 bis 46</p> |  |

Stand 07/24

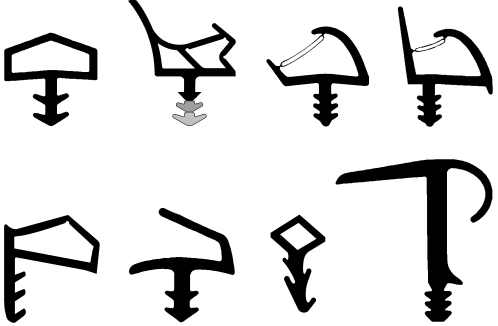
| | |
|--|--|
| <p>Dichtungen die so oder ähnlich aussehen finden Sie auf:</p> <p>Seite 50 bis 51</p> |  |
| <p>Dichtungen die so oder ähnlich aussehen finden Sie auf:</p> <p>Seite 55 bis 63</p> |  |
| <p>Dichtungen die so oder ähnlich aussehen finden Sie auf:</p> <p>Seite 70 bis 77</p> |  |
| | |



Stand 07/24

| | |
|--|--|
| <p>Dichtungen die so oder ähnlich aussehen finden Sie auf:</p> <p>Seite 80 bis 83</p> |  |
| <p>Dichtungen die so oder ähnlich aussehen finden Sie auf:</p> <p>Seite 90 bis 94</p> |  |
| <p>Dichtungen die so oder ähnlich aussehen finden Sie auf:</p> <p>Seite 100</p> |  |
| <p>Dichtungen die so oder ähnlich aussehen finden Sie auf:</p> <p>Seite 105 bis 107</p> |  |

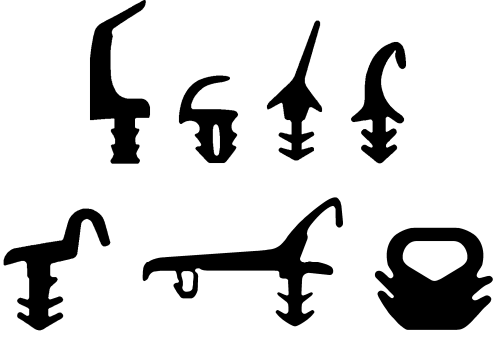
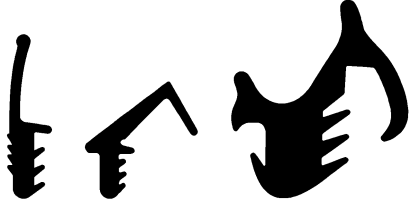
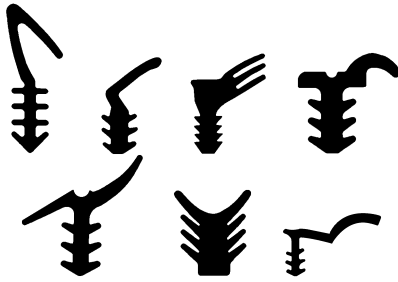
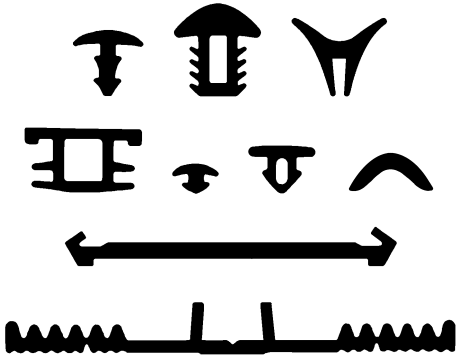
Stand 07/24

| | |
|--|--|
| <p>Dichtungen die so oder ähnlich aussehen finden Sie auf:</p> <p>Seite 110 bis 112</p> |  |
| <p>Dichtungen die so oder ähnlich aussehen finden Sie auf:</p> <p>Seite 115</p> |  |
| <p>Dichtungen die so oder ähnlich aussehen finden Sie auf:</p> <p>Seite 120 bis 121</p> |  |
| <p>Dichtungen die so oder ähnlich aussehen finden Sie auf:</p> <p>Seite 125 bis 130</p> |  |

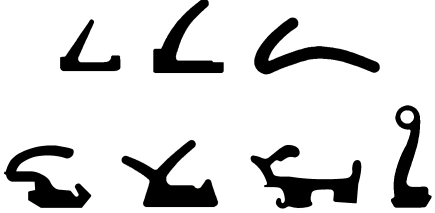
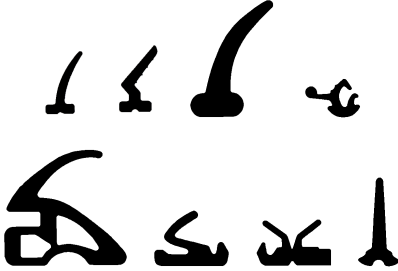
Stand 07/24

| | |
|--|--|
| <p>Dichtungen die so oder ähnlich aussehen finden Sie auf:</p> <p>Seite 135 bis 141</p> |  |
| <p>Dichtungen die so oder ähnlich aussehen finden Sie auf:</p> <p>Seite 145 bis 150</p> |  |
| <p>Dichtungen die so oder ähnlich aussehen finden Sie auf:</p> <p>Seite 155 bis 156</p> |  |
| <p>Dichtungen die so oder ähnlich aussehen finden Sie auf:</p> <p>Seite 160 bis 167</p> |  |

Stand 07/24

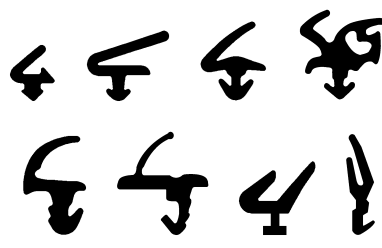
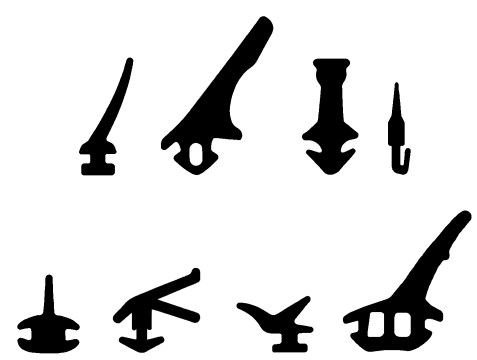
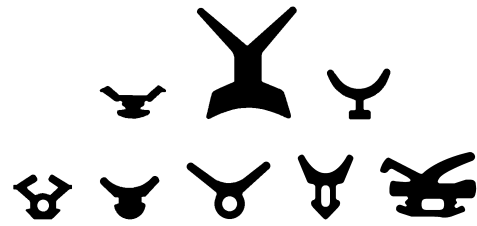
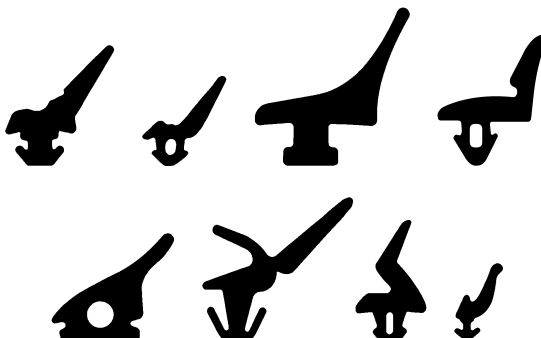
| | |
|---|--|
| <p>Dichtungen die so oder ähnlich aussehen finden Sie auf:</p> <p>Seite 170 bis 172</p> |  |
| <p>Dichtungen die so oder ähnlich aussehen finden Sie auf:</p> <p>Seite 175 bis 179</p> |  |
| <p>Dichtungen die so oder ähnlich aussehen finden Sie auf:</p> <p>Seite 185 bis 187</p> |  |
| <p>Dichtungen die so oder ähnlich aussehen finden Sie auf:</p> <p>Seite 190 bis 192a</p> |  |

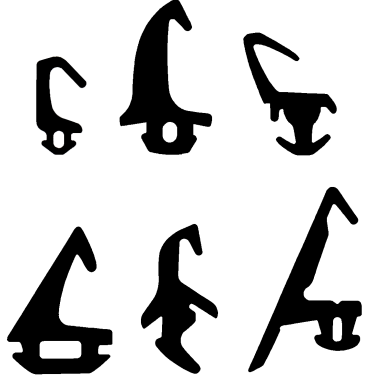
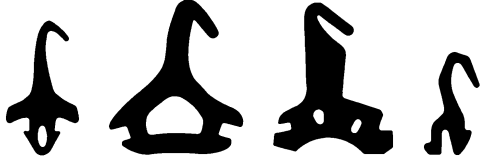
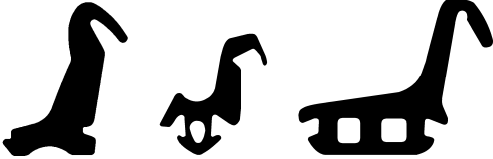
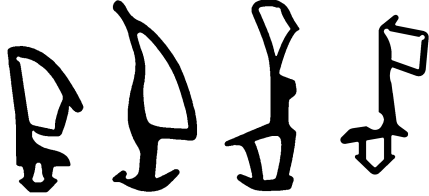

Stand 07/24

| | |
|--|--|
| <p>Dichtungen die so oder ähnlich aussehen finden Sie auf:</p> <p>Seite 195 bis 199</p> |  |
| <p>Dichtungen die so oder ähnlich aussehen finden Sie auf:</p> <p>Seite 205 bis 206</p> |  |
| <p>Dichtungen die so oder ähnlich aussehen finden Sie auf:</p> <p>Seite 210 bis 211</p> |  |
| <p>Dichtungen die so oder ähnlich aussehen finden Sie auf:</p> <p>Seite 214</p> |  |

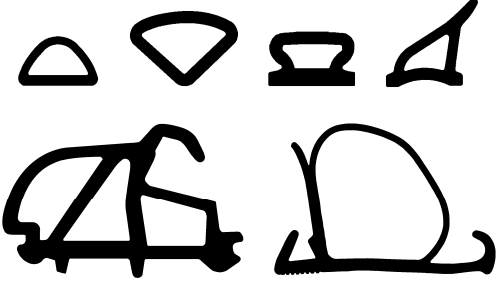
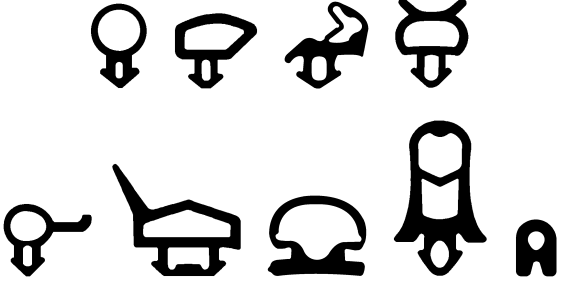
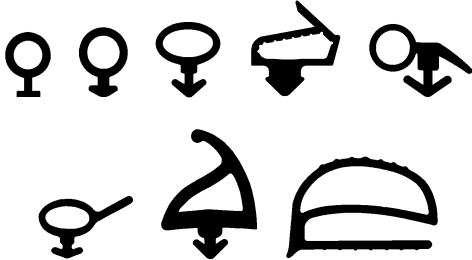
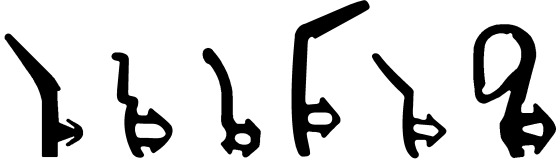

Stand 07/24

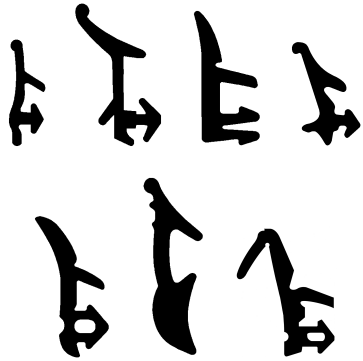
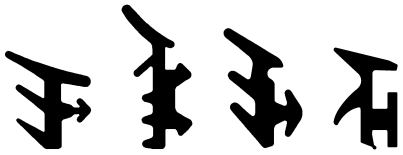
| | |
|--|--|
| <p>Dichtungen die so oder ähnlich aussehen finden Sie auf:</p> <p>Seite 215 bis 219</p> |  |
| <p>Dichtungen die so oder ähnlich aussehen finden Sie auf:</p> <p>Seite 225 bis 232</p> |  |
| <p>Dichtungen die so oder ähnlich aussehen finden Sie auf:</p> <p>Seite 240 bis 242</p> |  |
| <p>Dichtungen die so oder ähnlich aussehen finden Sie auf:</p> <p>Seite 245 bis 248</p> |  |

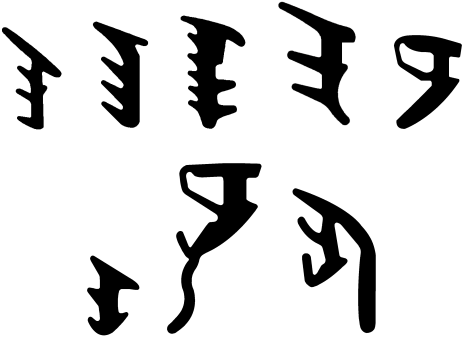

Stand 07/24

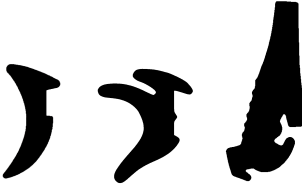
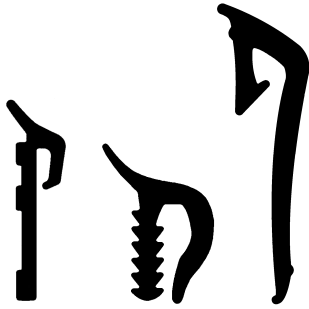
| | |
|--|--|
| <p>Dichtungen die so oder ähnlich aussehen finden Sie auf:</p> <p>Seite 255 bis 256</p> |  |
| <p>Dichtungen die so oder ähnlich aussehen finden Sie auf:</p> <p>Seite 260 bis 262</p> |  |
| <p>Dichtungen die so oder ähnlich aussehen finden Sie auf:</p> <p>Seite 265 bis 266</p> |  |
| <p>Dichtungen die so oder ähnlich aussehen finden Sie auf:</p> <p>Seite 270 bis 273</p> |  |

Stand 07/24

| | |
|--|---|
| <p>Dichtungen die so oder ähnlich aussehen finden Sie auf:</p> <p>Seite 275 bis 276</p> |  |
| <p>Dichtungen die so oder ähnlich aussehen finden Sie auf:</p> <p>Seite 280 bis 281</p> |  |
| <p>Dichtungen die so oder ähnlich aussehen finden Sie auf:</p> <p>Seite 285 bis 287</p> |  |
| <p>Dichtungen die so oder ähnlich aussehen finden Sie auf:</p> <p>Seite 290 bis 292</p> |  |

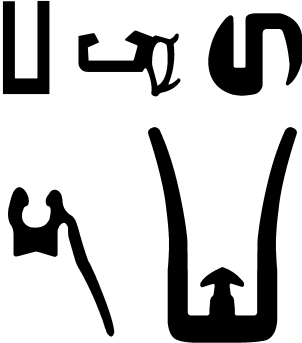
Stand 07/24

| | |
|--|--|
| <p>Dichtungen die so oder ähnlich aussehen finden Sie auf:</p> <p>Seite 300</p> |  |
| <p>Dichtungen die so oder ähnlich aussehen finden Sie auf:</p> <p>Seite 305 bis 308</p> |  |
| <p>Dichtungen die so oder ähnlich aussehen finden Sie auf:</p> <p>Seite 315</p> |  |
| <p>Dichtungen die so oder ähnlich aussehen finden Sie auf:</p> <p>Seite 320</p> |  |

Stand 07/24

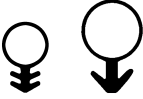
| | |
|--|---|
| <p>Dichtungen die so oder ähnlich aussehen finden Sie auf:</p> <p>Seite 325</p> |  |
| | |
| | |
| <p>Allgemeine Verkaufs- und Lieferbedingungen finden Sie auf:</p> <p>der nächsten Seite</p> | <p>Bitte beachten Sie, dass unsere Waren vom Umtausch und Rückgabe ausgeschlossen sind.</p> |

Stand 07/24

**Allgemeine Verkaufs- und Lieferbedingungen für
Hamster-Dichtungen GmbH - Gf.: René Strelow und André Strelow
Im Hollandshagen 2 – 21436 Marschacht (Eichholz)**

A. Vertragsabschluss:

Wir liefern ausschließlich zu unseren nachstehenden Allgemeinen Verkaufs- und Lieferbedingungen. Anderslautende Bedingungen unserer Kunden werden nur dann Vertragsbestandteil, wenn wir sie ausdrücklich schriftlich anerkannt haben.

B. Preise / Zahlungen:

1. Wir sind berechtigt, Teillieferungen jeweils gesondert zu berechnen.
2. Unsere Rechnungen sind innerhalb von 14 Tagen, gerechnet ab Rechnungsdatum - zahlbar.
3. Bei verspäteter Zahlung haben wir das Recht, Verzugszinsen in Höhe von 5% über dem Basiszinssatz zu berechnen.
4. Wechselsteuern, Diskontspesen, Einziehungsgebühren und Kosten für Überweisungen von Auslandskunden übernehmen wir nicht.
5. Wir sind zur Annahme von Wechseln nicht verpflichtet. Sollten sich bereits angenommene Wechsel als nicht diskontfähig erweisen, so sind wir zur Rückgabe und Forderung auf Barzahlung des Kaufpreises berechtigt.
6. Bei nicht rechtzeitiger Vorlage oder nicht fristgemäßen Protest von Wechseln haften wir nur für grobes Verschulden.
7. Bei allen Kaufverträgen sind wir zur Prüfung der Zahlungsfähigkeit des betreffenden Kunden berechtigt. Im Zweifelsfall können wir Vorauskasse oder Sicherheiten zur Abdeckung des Kaufpreises fordern. Wird uns bei einem Kunden eine verschlechterte Zahlungsfähigkeit bekannt, so können wir die sofortige Zahlung auch dann verlangen, wenn der Auftrag bereits zu den unter B 2 genannten Zahlungsbedingungen bestätigt wurde.

C. Lieferung / Gefahrenübergang:

1. Maßgeblich für Qualität und Ausführung sind Ausfallmuster, die wir unseren Kunden auf Anforderung vor der Lieferung zur Prüfung zusenden. Wir behalten uns bei der Lieferung geringfügige Änderungen gegenüber den Ausfallmustern in Bezug auf Form, Abmessungen, Qualität und Gewicht sowie Farbe vor.
2. Wir sind berechtigt, Mehr- oder Minderlieferungen bis zu höchstens 10% gegenüber den in der Bestätigung genannten Mengen ohne vorherige Abstimmung mit unseren Kunden vorzunehmen.
3. Wenn nicht ausdrücklich anders vereinbart, erfolgt die Lieferung ab Lager.
4. Der Versand erfolgt auf Rechnung und Gefahr unserer Kunden; dies gilt auch für die Lieferung am Erfüllungsort.
5. Ist frachtfreie Lieferung vereinbart, so erfolgt der Versand auf dem für uns kostengünstigsten Versandweg. Mehrkosten für besondere Versandwünsche und für eine Transportversicherung gehen zu Lasten unserer Kunden.
6. Ist Selbstabholung in unserem Lager vereinbart, so hat der betreffende Kunde die Ware unverzüglich zu übernehmen, sobald wir ihm die Versandbereitschaft gemeldet haben. Mit dem Zeitpunkt der Meldung geht die Gefahr des zufälligen Unterganges oder der zufälligen Verschlechterung auf den Kunden über.

D. Lieferzeit:

1. Wir sind stets bemüht, vereinbarte und von uns bestätigte Liefertermine einzuhalten. Dennoch müssen wir uns eine Überschreitung einer zugesagten Lieferzeit aus wichtigen Gründen um längstens 4 Wochen vorbehalten.
2. Sollte eine Lieferung entgegen aller Bemühungen dann noch nicht erfolgt sein, so ist uns eine Nachfrist von wenigstens 3 Wochen zu setzen.
3. Sollten Umstände eintreten, die uns die Vertragserfüllung wesentlich erschweren oder gänzlich unmöglich machen - wie beispielsweise Krieg, Aufruhr, Streiks, behördliche Maßnahmen und andere Fälle höherer Gewalt - so geraten wir dadurch nicht in Verzug. In einem solchen Falle haben wir das Recht, vom Vertrag zurückzutreten. Dies gilt auch, falls einer unserer Zulieferer sich außerstande sieht, seine Verpflichtungen uns gegenüber zu erfüllen, ohne daß uns hierbei ein grobes Verschulden trifft.

E. Eigentumsvorbehalt:

1. Bis zur vollständigen Bezahlung des Kaufpreises sowohl aus diesem Vertrag als auch unserer Forderungen aus der Geschäftsverbindung behalten wir uns das Eigentum an den gelieferten Waren vor. Der betreffende Kunde darf bis dahin die gelieferten Waren weder verpfänden noch sicherungsübereignen.
2. Sollte der betreffende Kunde die unter diesem Eigentumsvorbehalt gelieferten Waren weiterverkaufen, so tritt er bereits jetzt seine Ansprüche gegenüber Dritten aus dem Verkauf an uns ab.
3. Im Falle der Weiterverarbeitung der unter diesem Eigentumsvorbehalt gelieferten Waren, erwirbt der Kunde bis zur Zahlung aller unserer Forderungen aus der Geschäftsverbindung kein Eigentum an der bezogenen Ware. Bei der Verarbeitung erstreckt sich unser Anspruch auf den anteiligen Wert unserer Ware an der neuen Sache. Der betreffende Kunde tritt schon jetzt sein Eigentum bzw. Miteigentum bis zur Höhe des anteiligen Wertes an der neuen Sache an uns ab.







F. Mängelrügen:







1. Der Kunde ist zur sofortigen Prüfung der von uns gelieferten Ware verpflichtet. Er hat uns etwaige Mängel innerhalb von 8 Tagen nach Warenerhalt bekanntzugeben.
2. Im Falle berechtigter und von uns schriftlich anerkannter Mängel hat der Kunde zunächst nur das Recht, von uns Ersatzlieferung in einwandfreier Ausführung oder Nachbesserung zu verlangen. Er hat uns für die Erledigung eine angemessene Nachfrist zu setzen.
3. Erst wenn eine Ersatzlieferung unmöglich ist oder die Nachbesserung fehlschlägt, hat der Kunde Anspruch auf Erstattung durch Gutschrift.
4. Bei nachgewiesenen und von uns anerkannten Mängeln erstreckt sich unsere Haftung auf Grund der allgemeinen Gewährleistungsansprüche höchstens auf den Rechnungswert der im Rahmen des betreffenden Kaufvertrages gelieferten Ware. Die Haftung für Folgeschäden ist grundsätzlich ausgeschlossen.
5. Wir haften nicht dafür, daß die von uns gelieferte Ware für den vom Kunden gedachten Verwendungszweck geeignet ist. Wir sind jedoch bereit, ihn über die Eignung unserer Ware für den vorgesehenen Zweck nach bestem Wissen zu beraten (Beispiel: Prüfung einer Verträglichkeit, usw.)





G. Erfüllungsort und Gerichtsstand:





1. Erfüllungsort für die Pflichten beider Vertragspartner aus diesem Vertrag ist:
Marschacht
2. Gerichtsstand im Rechtsverhältnis mit Kaufleuten ist der nachstehend genannte Ort; für Nichtkaufleute gilt dieser Gerichtsstand für das Mahnverfahren als vereinbart:
Winsen/Luhe

Marschacht (Eichholz), 2024

| | | | | | |
|---|---|---|---|---|---|
| Z 557 be/br/gr/w | Z 513 gr | Z 618 gr | Z 634 gr | Z 657 be/gr/w | Z 908 gr/w |
|  |  |  |  |  |  |

| | | | | | |
|---|---|--|---|---|---|
| Z 529-B gr/w | Z 635 gr | Z 1073 | Z 7516 | Z 557-A gr/w | Z 557-B gr/w |
|  |  |  |  |  |  |

| | | | | | |
|---|---|---|--|---|---|
| Z 535 gr/w | Z 541 gr | Z 525 gr/w | | Z 636 gr | Z 1014 gr |
|  |  |  | |  |  |

| | | | | | |
|---|---|---|---|--|---|
| Z 569 gr/w | Z 591 gr/w | Z 589 gr/w | Z 511 gr/w | | Z 953 gr |
|  |  |  |  | |  |

Genauere Angaben zu den Farben, Werkstoffen und Abnahmemengen siehe bitte Preisliste. Konstruktionsänderungen an den Querschnitten vorbehalten - Zur Abklärung der Passgenauigkeit bitte vor Bestellung ein 10cm-Muster anfordern. Lieferung ab Warenwert € 40,- netto frei Haus, ansonsten zzgl. € 6,95 netto Fracht. Maßstab: ca. 1:1. Stand 02/23.

Renovierungs-Dichtungen für Stahlzargen









| | | | | | |
|-------------|-------------|-------------|-------------|-------------|-------------|
| Z 940 gr | Z 944 gr | Z 947 gr | Z 984 gr | Z 943 gr | Z 931 gr |
| | | | | | |





| | | | | | |
|------------------|---------------|-------------|---------------|-------------|---------------|
| Z 594 be/gr/w | Z 554 gr/w | Z 599 gr | Z 620 gr/w | Z 621 gr | Z 622 gr/w |
| | | | | | |





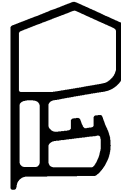

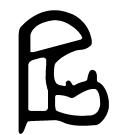
| | | | | | |
|-------------|---------------|--------------|-------------|-------------|-------------|
| Z 559 gr | Z 595 gr/w | Z 1009 gr | Z 935 gr | Z 640 gr | Z 619 gr |
| | | | | | |





| | | | | | |
|-------------|-------------|-------|--|--|--|
| Z 617 gr | Z 585 gr | Z 934 | | | |
| | | | | | |

Genauere Angaben zu den Farben, Werkstoffen und Abnahmemengen siehe bitte Preisliste. Konstruktionsänderungen an den Querschnitten vorbehalten - Zur Abklärung der Passgenauigkeit bitte vor Bestellung ein 10cm-Muster anfordern. Lieferung ab Warenwert € 40,- netto frei Haus, ansonsten zzgl. € 6,95 netto Fracht. Maßstab: ca. 1:1. Stand 03/22.



| | | | | | |
|---|---|---|---|---|---|
| Z 638 gr | Z 649 gr | Z 505 gr/w | Z 687 gr | Z 600 gr | Z 637 gr |
|  |  |  |  |  |  |



| | | | | | |
|---|--|---|---|---|---|
| Z 518 gr/w | Z 538 gr | Z 596 gr/w | Z 596-A gr | Z 566 gr/w | Z 540 gr |
|  |  |  |  |  |  |

| | | | | | |
|---|---|---|---|---|---|
| Z 561 gr | Z 582 gr | Z 572 gr | Z 644 gr | Z 933 | Z 660 |
|  |  |  |  |  |  |



| | | | | | |
|---|--|---|---|--|---|
| Z 1057 | | Z 1035 gr | Z 670 | | Z 1036 |
|  | |  |  | |  |

Genauere Angaben zu den Farben, Werkstoffen und Abnahmemengen siehe bitte Preisliste. Konstruktionsänderungen an den Querschnitten vorbehalten - Zur Abklärung der Passgenauigkeit bitte vor Bestellung ein 10cm-Muster anfordern. Lieferung ab Warenwert € 40,- netto frei Haus, ansonsten zzgl. € 6,95 netto Fracht. Maßstab: ca. 1:1. Stand 02/23.

| | | | | | |
|---|---|--|--|--|--|
| Z 568 gr/w | Z 1065 | | | | |
|  |  | | | | |

| | | | | | |
|--|---|--|---|--|--|
| | Z 641 gr | | Z 642 gr | | |
| |  | |  | | |

| | | | | | |
|--|--|--|--|--|--|
| | | | | | |
| | | | | | |

| | | | | | |
|--|--|---|--|--|---|
| | | Z 7546 sw | | | Z 956 |
| | |  | | |  |

Genauere Angaben zu den Farben, Werkstoffen und Abnahmemengen siehe bitte Preisliste. Konstruktionsänderungen an den Querschnitten vorbehalten - Zur Abklärung der Passgenauigkeit bitte vor Bestellung ein 10cm-Muster anfordern. Lieferung ab Warenwert € 40,- netto frei Haus, ansonsten zzgl. € 6,95 netto Fracht. Maßstab: ca. 1:1. Stand 05/22.

Renovierungs-Dichtungen für Stahlzargen



| | | | | | |
|---------------|-------------|--|-------------|-------------|-------------|
| Z 613 gr/w | Z 543 gr | | Z 662 gr | Z 524 gr | Z 516 gr |
| | | | | | |

| | | | | | |
|-------------|-------------|-------------|-------------|-------------|-------|
| Z 632 gr | Z 571 gr | Z 937 gr | Z 612 gr | Z 574 gr | Z 973 |
| | | | | | |

| | | | | | |
|-------------|-------------|--|-------|-------------|-------------|
| Z 698 gr | Z 515 gr | | Z 939 | Z 611 gr | Z 971 gr |
| | | | | | |

| | | | | | |
|-------------|---------|-------------|-------------|-------------|---------------|
| Z 677 gr | Z 768-H | Z 936 gr | Z 579 gr | Z 549 gr | Z 548 gr/w |
| | | | | | |

Genauere Angaben zu den Farben, Werkstoffen und Abnahmemengen siehe bitte Preisliste. Konstruktionsänderungen an den Querschnitten vorbehalten - Zur Abklärung der Passgenauigkeit bitte vor Bestellung ein 10cm-Muster anfordern. Lieferung ab Warenwert € 40,- netto frei Haus, ansonsten zzgl. € 6,95 netto Fracht. Maßstab: ca. 1:1. Stand 07/24.

Renovierungs-Dichtungen für Stahlzargen





| | | | | | |
|-------|--------------|--------|--------|--------|--------|
| Z 920 | Z 1044 gr | Z 1049 | Z 1054 | Z 1043 | Z 7530 |
| | | | | | |



| | | | | | |
|-------------|-------------|--|--------------|--|--|
| Z 546 gr | Z 651 gr | | Z 1068 gr | | |
| | | | | | |



| | | | | | |
|--|--|--|--|--|--|
| | | | | | |
| | | | | | |



| | | | | | |
|--|--|--|--|--|--|
| | | | | | |
| | | | | | |

Genauere Angaben zu den Farben, Werkstoffen und Abnahmemengen siehe bitte Preisliste. Konstruktionsänderungen an den Querschnitten vorbehalten - Zur Abklärung der Passgenauigkeit bitte vor Bestellung ein 10cm-Muster anfordern. Lieferung ab Warenwert € 40,- netto frei Haus, ansonsten zzgl. € 6,95 netto Fracht. Maßstab: ca. 1:1. Stand 03/23.

| | | |
|---|---|---|
| Z 633 gr | Z 520 gr/w | Z 623 |
|  |  |  |

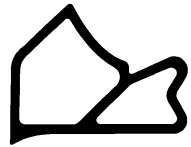
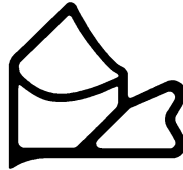

| | | |
|---|---|---|
| Z 688 gr | Z 523 gr/w | Z 506 gr |
|  |  |  |

| | | |
|---|---|---|
| Z 556 gr | Z 958 gr/w | Z 959 gr/w |
|  |  |  |

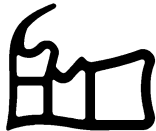
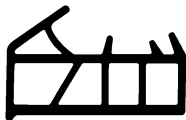

| | | |
|---|---|---|
| Z 941 gr | Z 1072 gr/w | Z 7517 |
|  |  |  |

Genauere Angaben zu den Farben, Werkstoffen und Abnahmemengen siehe bitte Preisliste. Konstruktionsänderungen an den Querschnitten vorbehalten - Zur Abklärung der Passgenauigkeit bitte vor Bestellung ein 10cm-Muster anfordern. Lieferung ab Warenwert € 40,- netto frei Haus, ansonsten zzgl. € 6,95 netto Fracht. Maßstab: ca. 1:1. Stand 03/23.

| | | |
|---|---|---|
| Z 659 gr | Z 678 | Z 946 gr |
|  |  |  |

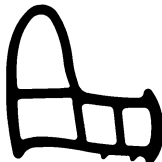
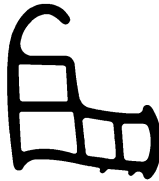
| | | |
|---|--|---|
| Z 1015 | | Z 685 gr |
|  | |  |

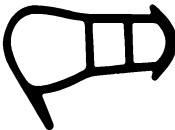
| | | |
|---|---|---|
| Z 573 gr | Z 992 gr | Z 997 |
|  |  |  |

| | | |
|---|---|---|
| Z 1002 | Z 645 gr | Z 693 gr |
|  |  |  |

Genauere Angaben zu den Farben, Werkstoffen und Abnahmemengen siehe bitte Preisliste. Konstruktionsänderungen an den Querschnitten vorbehalten - Zur Abklärung der Passgenauigkeit bitte vor Bestellung ein 10cm-Muster anfordern. Lieferung ab Warenwert € 40,- netto frei Haus, ansonsten zzgl. € 6,95 netto Fracht. Maßstab: ca. 1:1. Stand 01/23.

Renovierungs-Dichtungen für Stahlzargen



| | | | | | |
|-------------|-------------|-------------|-------------|-------------|-------------|
| Z 567 gr | Z 536 gr | Z 680 gr | Z 560 gr | Z 558 gr | Z 522 gr |
| | | | | | |

| | | | | | |
|-------------|--|--|--|-------------|--|
| Z 658 gr | | | | Z 7545 w | |
| | | | | | |

| | | |
|--|-------------|--------|
| | Z 681 gr | Z 1027 |
| | | |

| | | |
|-------------|--|--|
| Z 913 gr | | |
| | | |

Genauere Angaben zu den Farben, Werkstoffen und Abnahmemengen siehe bitte Preisliste. Konstruktionsänderungen an den Querschnitten vorbehalten - Zur Abklärung der Passgenauigkeit bitte vor Bestellung ein 10cm-Muster anfordern. Lieferung ab Warenwert € 40,- netto frei Haus, ansonsten zzgl. € 6,95 netto Fracht. Maßstab: ca. 1:1. Stand 03/23.

Renovierungs-Dichtungen für Stahlzargen





| | | | | | |
|-------------|-------------|-------------|-------------|---------------|-------|
| Z 517 gr | Z 942 gr | Z 606 gr | Z 652 gr | Z 519 gr/w | Z 968 |
| | | | | | |



| | | | | | |
|-------|--|--------|--|--------|--|
| Z 689 | | Z 1008 | | Z 1070 | |
| | | | | | |

| | | |
|-------|--------|-------------|
| Z 639 | Z 1047 | Z 576 gr |
| | | |



| | | |
|--------------|--------|--------------|
| Z 1042 gr | Z 1045 | Z 1037 gr |
| | | |

Genauere Angaben zu den Farben, Werkstoffen und Abnahmemengen siehe bitte Preisliste. Konstruktionsänderungen an den Querschnitten vorbehalten - Zur Abklärung der Passgenauigkeit bitte vor Bestellung ein 10cm-Muster anfordern. Lieferung ab Warenwert € 40,- netto frei Haus, ansonsten zzgl. € 6,95 netto Fracht. Maßstab: ca. 1:1. Stand 02/23.

| Z 1013 | Z 1019 sw | Z 1001 gr |
|---|---|---|
|  |  |  |

| Z 1020 | Z 1025 | Z 1026 |
|---|---|---|
|  |  |  |

| Z 7525 sw/w | | | | |
|---|--|--|--|--|
|  | | | | |

| Z 7538 gr | Z 7529 sw | Z 7503 |
|---|---|---|
|  |  |  |

Genauere Angaben zu den Farben, Werkstoffen und Abnahmemengen siehe bitte Preisliste. Konstruktionsänderungen an den Querschnitten vorbehalten - Zur Abklärung der Passgenauigkeit bitte vor Bestellung ein 10cm-Muster anfordern. Lieferung ab Warenwert € 40,- netto frei Haus, ansonsten zzgl. € 6,95 netto Fracht. Maßstab: ca. 1:1. Stand 02/23.

Renovierungs-Dichtungen für Stahlzargen



| | | | | | |
|------------------|-------------|-------------|--|--|-------|
| Z 501 br/gr/w | Z 671 gr | Z 604 gr | | | Z 961 |
| | | | | | |

| | | | | | |
|---------------------|---------------|---------------|------------------|-------------|-------|
| Z 530 br/gr/sw/w | Z 502 gr/w | Z 664 gr/w | Z 661 gr/sw/w | Z 630 gr | Z 903 |
| | | | | | |

| | | | | | |
|------------------|---------------|---------------|---------------|---------------|-------------|
| Z 527 br/gr/w | Z 666 gr/w | Z 533 gr/w | Z 580 gr/w | Z 964 gr/w | Z 508 gr |
| | | | | | |

| | | | | | |
|-------------|--|--|---------|--|-------|
| Z 954 gr | | | Z 580-A | | Z 950 |
| | | | | | |

Genauere Angaben zu den Farben, Werkstoffen und Abnahmemengen siehe bitte Preisliste. Konstruktionsänderungen an den Querschnitten vorbehalten - Zur Abklärung der Passgenauigkeit bitte vor Bestellung ein 10cm-Muster anfordern. Lieferung ab Warenwert € 40,- netto frei Haus, ansonsten zzgl. € 6,95 netto Fracht. Maßstab: ca. 1:1. Stand 01/23.

Renovierungs-Dichtungen für Stahlzargen



| | | | | | |
|---------------|---------------|-------------|--------------|-------------|-------|
| Z 690 gr/w | Z 526 gr/w | Z 694 gr | Z 1007 gr | Z 691 gr | Z 945 |
| | | | | | |

| | | | | | |
|-------------|-------------|--|--|--------|----------|
| Z 547 gr | Z 673 gr | | | Z 1048 | Z 1048-A |
| | | | | | |

| | | | | | |
|-------|-------------|--|--|--|--|
| Z 692 | Z 537 gr | | | | |
| | | | | | |

| | | | | | |
|--------------|-------|--|--|--|--------------|
| Z 1021 gr | Z 906 | | | | Z 7522 sw |
| | | | | | |

Genauere Angaben zu den Farben, Werkstoffen und Abnahmemengen siehe bitte Preisliste. Konstruktionsänderungen an den Querschnitten vorbehalten - Zur Abklärung der Passgenauigkeit bitte vor Bestellung ein 10cm-Muster anfordern. Lieferung ab Warenwert € 40,- netto frei Haus, ansonsten zzgl. € 6,95 netto Fracht. Maßstab: ca. 1:1. Stand 03/22.

Renovierungs-Dichtungen für Stahlzargen



| | | | | | |
|------------------|--------------------|-----------------|--------------|-------------|-------------|
| Z 647 gr/sw/w | Z 647-A gr/sw/w | Z 647-B gr/w | Z 1114 gr | Z 565 gr | Z 901 gr |
| | | | | | |

| | | | | | |
|---------------|---------------|---------------|-----------------|-----------------------|---------------|
| Z 697 gr/w | Z 624 gr/w | Z 592 gr/w | Z 592-A gr/w | Z 514-A br/gr/sw/w | Z 514 gr/w |
| | | | | | |

| | | | | | |
|-------------|-------------|--|-------------|---------------|-------------|
| Z 926 gr | Z 963 gr | | Z 528 gr | Z 980 gr/w | Z 553 gr |
| | | | | | |

| | | | | | |
|-------------|-------------|---------------|---------------|-------------|-------------|
| Z 902 gr | Z 990 gr | Z 625 gr/w | Z 626 gr/w | Z 504 gr | Z 648 gr |
| | | | | | |

Genauere Angaben zu den Farben, Werkstoffen und Abnahmemengen siehe bitte Preisliste. Konstruktionsänderungen an den Querschnitten vorbehalten - Zur Abklärung der Passgenauigkeit bitte vor Bestellung ein 10cm-Muster anfordern. Lieferung ab Warenwert € 40,- netto frei Haus, ansonsten zzgl. € 6,95 netto Fracht. Maßstab: ca. 1:1. Stand 03/22.

Renovierungs-Dichtungen für Stahlzargen



| | | | | | |
|------------------|-------------------|--|----------------|--|-------------|
| Z 532 gr/sw/w | Z 1095 gr/sw/w | | Z 2000 gr/w | | Z 988 gr |
| | | | | | |

| | | | | | |
|--|--------------|--|--------------|--|-----------------|
| | Z 7544 gr | | Z 7547 gr | | Z 7534 gr/sw |
| | | | | | |

| | | | | | |
|--------------|--------------|--|--|--|--|
| Z 7532 sw | Z 7518 sw | | | | |
| | | | | | |

| | | | | |
|--------|--|--------|--|--------------|
| Z 7535 | | Z 7531 | | Z 7542 sw |
| | | | | |

Genauere Angaben zu den Farben, Werkstoffen und Abnahmemengen siehe bitte Preisliste. Konstruktionsänderungen an den Querschnitten vorbehalten - Zur Abklärung der Passgenauigkeit bitte vor Bestellung ein 10cm-Muster anfordern. Lieferung ab Warenwert € 40,- netto frei Haus, ansonsten zzgl. € 6,95 netto Fracht. Maßstab: ca. 1:1. Stand 03/23.

Renovierungs-Dichtungen für Stahlzargen







| | | | | | |
|-------------|-------------|------------------|-------------------|----------------|-------------|
| Z 674 gr | Z 974 gr | Z 577 gr/sw/w | Z 1133 gr/sw/w | Z 1133-B gr | Z 672 gr |
| | | | | | |







| | | | | | |
|--------|--------------|--|--------|-------------|--------------|
| Z 1033 | Z 1038 gr | | Z 1028 | Z 603 gr | Z 1074 gr |
| | | | | | |

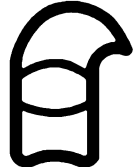



| | | | | | |
|-------------|---------------|---------------|--------------------|-------------|-------------|
| Z 584 gr | Z 650 gr/w | Z 923 gr/w | Z 923-B gr/sw/w | Z 905 gr | Z 583 gr |
| | | | | | |





| | | | | | |
|-------------|-------------|-------------|--------------|--------------|-------------|
| Z 998 gr | Z 991 gr | Z 627 gr | Z 7509 gr | Z 1062 gr | Z 981 gr |
| | | | | | |

Genauere Angaben zu den Farben, Werkstoffen und Abnahmemengen siehe bitte Preisliste. Konstruktionsänderungen an den Querschnitten vorbehalten - Zur Abklärung der Passgenauigkeit bitte vor Bestellung ein 10cm-Muster anfordern. Lieferung ab Warenwert € 40,- netto frei Haus, ansonsten zzgl. € 6,95 netto Fracht. Maßstab: ca. 1:1. Stand 01/23.

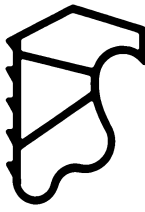
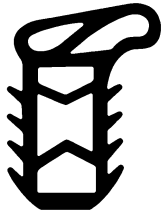
| | | | | | |
|---|---|---|---|---|---|
| Z 562 gr | Z 531 gr | Z 578 gr/w | Z 578-A w | Z 1022 | Z 1067 |
|  |  |  |  |  |  |

| | | | | | |
|---|---|--|---|--|---|
| Z 503 gr | Z 521 gr | Z 552 gr | Z 7524 gr | Z 7515 gr | Z 7513 gr |
|  |  |  |  |  |  |

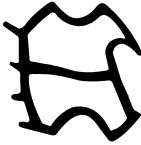
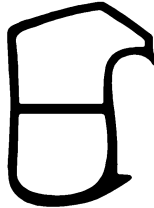
| | | | | | |
|---|---|---|---|---|---|
| Z 646 gr | Z 930 gr | Z 929 gr/w | Z 938 gr | Z 684 | Z 7501 sw |
|  |  |  |  |  |  |

| | | | | | |
|---|---|---|---|---|---|
| Z 1145 gr | Z 1134 gr | Z 7510 gr | Z 1010 sw | Z 679 | Z 907 |
|  |  |  |  |  |  |

Genauere Angaben zu den Farben, Werkstoffen und Abnahmemengen siehe bitte Preisliste. Konstruktionsänderungen an den Querschnitten vorbehalten - Zur Abklärung der Passgenauigkeit bitte vor Bestellung ein 10cm-Muster anfordern. Lieferung ab Warenwert € 40,- netto frei Haus, ansonsten zzgl. € 6,95 netto Fracht. Maßstab: ca. 1:1. Stand 01/23.

Renovierungs-Dichtungen für Stahlzargen









| | | | | | |
|-------------|-------------|--------------|-------------|-------------|--------|
| Z 663 gr | Z 668 gr | Z 1003 gr | Z 927 gr | Z 686 gr | Z 1023 |
| | | | | | |





| | | | | |
|-------|-------------|--------------|--------------|--------|
| Z 631 | Z 588 gr | Z 7505 gr | Z 7512 gr | Z 1055 |
| | | | | |





| | | | | | |
|-------------|-------------|-------------|-------------|-------------|-------------|
| Z 948 gr | Z 602 gr | Z 683 gr | Z 924 gr | Z 667 gr | Z 977 gr |
| | | | | | |





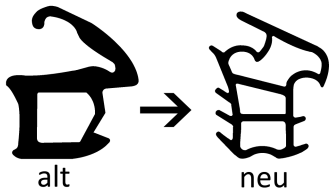

| | | | | |
|-------|-------------|--------|-------------|-------|
| Z 949 | Z 601 gr | Z 7502 | Z 972 gr | Z 965 |
| | | | | |

Genauere Angaben zu den Farben, Werkstoffen und Abnahmemengen siehe bitte Preisliste. Konstruktionsänderungen an den Querschnitten vorbehalten - Zur Abklärung der Passgenauigkeit bitte vor Bestellung ein 10cm-Muster anfordern. Lieferung ab Warenwert € 40,- netto frei Haus, ansonsten zzgl. € 6,95 netto Fracht. Maßstab: ca. 1:1. Stand 01/23.



| | | | | | |
|---|---|---|---|---|---|
| Z 655 gr | Z 970 gr | Z 1016 w | Z 911 | Z 982 gr | Z 909 gr |
|  |  |  |  |  |  |

| | | | | | |
|---|---|---|---|---|--|
| Z 976 gr | Z 605 gr | Z 1051 | Z 1052 gr/sw | Z 1053 | |
|  |  |  |  |  | |



| | | | | |
|--|---|---|---|---|
| Z 7511 sw | Z 676 gr | Z 7504 gr | Z 1061 | Z 1059 |
|  alt → neu |  |  |  |  |

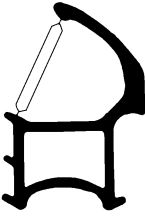

| | | | | | |
|---|---|---|---|--|---|
| Z 593 gr/sw | Z 550 gr/sw/w | Z 979 gr | Z 916 gr/sw | Z 7508 gr | Z 7536 gr |
|  |  |  |  |  verbesserte Version von Z 7536 |  |





Genauere Angaben zu den Farben, Werkstoffen und Abnahmemengen siehe bitte Preisliste. Konstruktionsänderungen an den Querschnitten vorbehalten - Zur Abklärung der Passgenauigkeit bitte vor Bestellung ein 10cm-Muster anfordern. Lieferung ab Warenwert € 40,- netto frei Haus, ansonsten zzgl. € 6,95 netto Fracht. Maßstab: ca. 1:1. Stand 02/23.

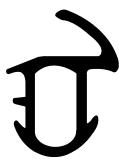



| | | | | | |
|---|---|--|--|---|--|
| Z 994 | Z 999 gr | | | | |
|  |  | | | | |
| | | | | | |
| | | | | | |
| | | | | | |
| | | | | Z 7540 | |
| | | | |  | |

Genauere Angaben zu den Farben, Werkstoffen und Abnahmemengen siehe bitte Preisliste. Konstruktionsänderungen an den Querschnitten vorbehalten - Zur Abklärung der Passgenauigkeit bitte vor Bestellung ein 10cm-Muster anfordern. Lieferung ab Warenwert € 40,- netto frei Haus, ansonsten zzgl. € 6,95 netto Fracht. Maßstab: ca. 1:1. Stand 03/23.







| | | | | | |
|--|---|---|---|--|--|
| | Z 978 sw | Z 614 gr | Z 928 gr | | |
| |  |  |  | | |







| | | | | | |
|--|--|--|--|--|---|
| | Z 7523 sw | Z 7514 gr/sw | Z 7521 gr/sw | | Z 7519 sw |
| |  |  |  | |  |



| | | | | | |
|---|---|---|---|--|---|
| Z 932 gr | Z 615 | Z 590 | Z 7526 | | Z 1102 sw |
|  |  |  |  | |  |

| | | | | | |
|---|---|---|---|--|---|
| Z 985 | Z 915 gr | Z 1012 | Z 7528 sw | | Z 7533 sw |
|  |  |  |  | |  |

Genauere Angaben zu den Farben, Werkstoffen und Abnahmemengen siehe bitte Preisliste. Konstruktionsänderungen an den Querschnitten vorbehalten - Zur Abklärung der Passgenauigkeit bitte vor Bestellung ein 10cm-Muster anfordern. Lieferung ab Warenwert € 40,- netto frei Haus, ansonsten zzgl. € 6,95 netto Fracht. Maßstab: ca. 1:1. Stand 07/24.

| | | | | | |
|---|---|---|---|---|---|
| Z 1160 sw | Z 1046 gr | Z 1050 gr | Z 669 gr | Z 7537 | Z 512 gr |
|  |  |  |  |  |  |

| | | | | | |
|---|---|---|---|---|--|
| Z 507 | Z 986 sw | Z 914 gr | Z 914-A gr | Z 1071 gr | Z 975 gr |
|  |  |  |  |  |  |

| | | | | | |
|--|--|--|---|---|---|
| | | | Z 665 sw | Z 1041 | Z 1077 gr |
| | | |  |  |  |

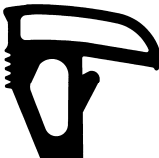
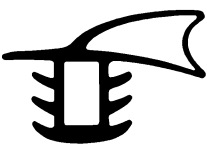
| | | |
|---|--|---|
| Z 7543 sw | | Z 1005 gr |
|  | |  |

Genauere Angaben zu den Farben, Werkstoffen und Abnahmemengen siehe bitte Preisliste. Konstruktionsänderungen an den Querschnitten vorbehalten - Zur Abklärung der Passgenauigkeit bitte vor Bestellung ein 10cm-Muster anfordern. Lieferung ab Warenwert € 40,- netto frei Haus, ansonsten zzgl. € 6,95 netto Fracht. Maßstab: ca. 1:1. Stand 03/23.

Renovierungs-Dichtungen für Stahlzargen







| | | | | | |
|-------------|-------------|-------------|-------------|--|-------------|
| Z 629 gr | Z 570 gr | Z 598 gr | Z 699 gr | | Z 682 gr |
| | | | | | |



| | | | | | |
|-------------|-------------|-------------|-------|--------------|-------|
| Z 921 gr | Z 628 gr | Z 581 gr | Z 989 | Z 7520 sw | Z 904 |
| | | | | | |





| | | | | | |
|-------------|---------------------|---------------|-------------|-------------|-------------|
| Z 597 gr | Z 510 br/gr/sw/w | Z 917-A gr | Z 922 gr | Z 925 gr | Z 919 tr |
| | | | | | |





| | | | | | |
|-------|-------|-------------|-------|--|--------|
| Z 996 | Z 675 | Z 542 gr | Z 960 | | Z 7527 |
| | | | | | |

Genauere Angaben zu den Farben, Werkstoffen und Abnahmemengen siehe bitte Preisliste. Konstruktionsänderungen an den Querschnitten vorbehalten - Zur Abklärung der Passgenauigkeit bitte vor Bestellung ein 10cm-Muster anfordern. Lieferung ab Warenwert € 40,- netto frei Haus, ansonsten zzgl. € 6,95 netto Fracht. Maßstab: ca. 1:1. Stand 03/23.

| | | | | | |
|---|---|---|---|---|--|
| Z 587 | Z 1030 | Z 610 | Z 1029 | Z 609 sw | |
|  |  |  |  |  | |

| | | | | | |
|---|---|--|--|--|--|
| Z 1058 | Z 607 gr | | | | |
|  |  | | | | |



| | | | | | |
|--|--|---|---|---|---|
| | | Z 555 gr | Z 555-A gr | Z 1056 gr | Z 643 |
| | |  |  |  |  |

| | | | | | |
|---|---|--|---|--|---|
| Z 616 | Z 1060 gr | | Z 545 | | Z 551 |
|  |  | |  | |  |

Genauere Angaben zu den Farben, Werkstoffen und Abnahmemengen siehe bitte Preisliste. Konstruktionsänderungen an den Querschnitten vorbehalten - Zur Abklärung der Passgenauigkeit bitte vor Bestellung ein 10cm-Muster anfordern. Lieferung ab Warenwert € 40,- netto frei Haus, ansonsten zzgl. € 6,95 netto Fracht. Maßstab: ca. 1:1. Stand 03/22.

Renovierungs-Dichtungen für Stahlzargen

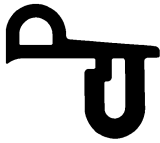

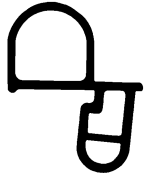
| Z 544 gr | Z 912 gr | Z 1018 gr | Z 1024 | | |
|---|---|---|---|--|--|
|  |  |  |  | | |

| Z 951 | Z 952 | | | | |
|--|--|--|--|--|--|
|  |  | | | | |

Genauere Angaben zu den Farben, Werkstoffen und Abnahmemengen siehe bitte Preisliste. Konstruktionsänderungen an den Querschnitten vorbehalten - Zur Abklärung der Passgenauigkeit bitte vor Bestellung ein 10cm-Muster anfordern. Lieferung ab Warenwert € 40,- netto frei Haus, ansonsten zzgl. € 6,95 netto Fracht. Maßstab: ca. 1:1. Stand 03/22.

Renovierungs-Dichtungen für Stahlzargen



| | | | | | |
|----------------------------------|--|-------------|-------------|----------------|-------------|
| M 701 gr | M 701-H gr/w | M 713 gr | M 742 gr | M 770 gr/sw | M 708 gr |
| | | | | | |
| Original-Profil aus Moosgummi | verbesserte Version mit Toleranzausgleich | | | 20 x 10mm | |

| | | | | | |
|----------------------------------|--|---|--|---|--|
| M 710 gr | M 710-B gr | M 728 gr | M 728-H gr/w | M 702 gr | M 702-H gr/w |
| | | | | | |
| Original-Profil aus Moosgummi | verbesserte Version mit Toleranzausgleich | 16 x 10mm Original-Profil aus Moosgummi | verbesserte Version mit Toleranzausgleich | 17 x 12mm Original-Profil aus Moosgummi | verbesserte Version mit Toleranzausgleich |

| | | | | | |
|-------------|----------------------------------|--|-------------|--|-------------|
| M 730 gr | M 727 gr | M 727-H gr/w | M 706 gr | | M 719 gr |
| | | | | | |
| | Original-Profil aus Moosgummi | verbesserte Version mit Toleranzausgleich | | | |

| | | | | | |
|-------------|-------------|--|--|-------------|-------------|
| M 704 gr | M 717 gr | | | M 715 gr | M 705 gr |
| | | | | | |
| | | | | | |

Genauere Angaben zu den Farben, Werkstoffen und Abnahmemengen siehe bitte Preisliste. Konstruktionsänderungen an den Querschnitten vorbehalten - Zur Abklärung der Passgenauigkeit bitte vor Bestellung ein 10cm-Muster anfordern. Lieferung ab Warenwert € 40,- netto frei Haus, ansonsten zzgl. € 6,95 netto Fracht. Maßstab: ca. 1:1. Stand 04/14.

Renovierungs-Dichtungen für Stahlzargen



| | | | | | |
|-------------|-------------|--|--|------------------------------|----------------------------|
| M 703 gr | M 736 gr | | | M 731 | M 731-H gr |
| | | | | ersetzt durch M 731-H | verbesserte Version |

| | | | | | |
|-------------|-------------|-------------|-------------|-----------------------------|--|
| M 734 gr | M 711 gr | M 712 gr | M 764 gr | Z 7541 sw | |
| | | | | ersetzt durch Z 7541 | verbesserte Version mit Toleranzausgleich |

| | | | | | |
|--------------------------------------|--|-----------------------------|--|-------------|-------|
| M 707 gr | M 707-H gr/w | | Z 7539 sw | M 724 gr | M 725 |
| Original-Profil aus Moosgummi | verbesserte Version mit Toleranzausgleich | ersetzt durch Z 7539 | verbesserte Version mit Toleranzausgleich | | |







| | | | | | |
|-------------|--|--|--|--|-------------|
| M 716 gr | | | | | M 765 sw |
| | | | | | |



Genauere Angaben zu den Farben, Werkstoffen und Abnahmemengen siehe bitte Preisliste. Konstruktionsänderungen an den Querschnitten vorbehalten - Zur Abklärung der Passgenauigkeit bitte vor Bestellung ein 10cm-Muster anfordern. Lieferung ab Warenwert € 40,- netto frei Haus, ansonsten zzgl. € 6,95 netto Fracht. Maßstab: ca. 1:1. Stand 05/22.

Renovierungs-Dichtungen für Stahlzargen



| M 801 sw | M 802 sw | M 803 sw | M 804 sw | M 753 gr/sw | |
|--|--|--|--|--|--|
|  2mm |  2,5mm |  3mm |  3,5mm |  4mm | |

| M 754 gr/sw | M 747 sw | M 755 sw | M 756 gr/sw | M 806 sw | M 740 gr/sw |
|--|--|--|--|--|---|
|  5mm |  6mm |  7mm |  8mm |  9mm |  10mm |

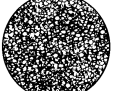
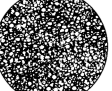
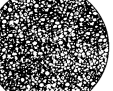
| M 807 sw | M 757 gr/sw | | M 714 gr/sw | M 809 sw | M 810 sw |
|---|---|--|---|---|---|
|  11mm |  12mm | |  14mm |  15mm |  16mm |

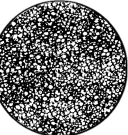
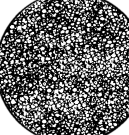
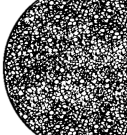
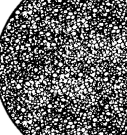
| M 811 sw | M 812 sw | M 813 sw | M 814 sw |
|---|---|---|---|
|  18mm |  20mm |  22mm |  25mm |

Genauere Angaben zu den Farben, Werkstoffen und Abnahmemengen siehe bitte Preisliste. Konstruktionsänderungen an den Querschnitten vorbehalten - Zur Abklärung der Passgenauigkeit bitte vor Bestellung ein 10cm-Muster anfordern. Lieferung ab Warenwert € 40,- netto frei Haus, ansonsten zzgl. € 6,95 netto Fracht. Maßstab: ca. 1:1. Stand 11/20.

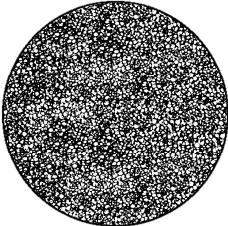
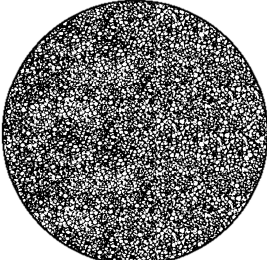
| | |
|---|--|
| M 815 SW | M 816 SW |
|  30mm |  35mm |

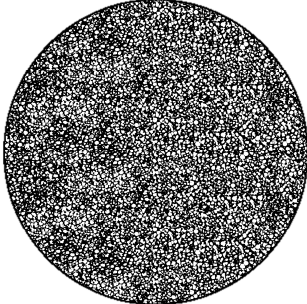
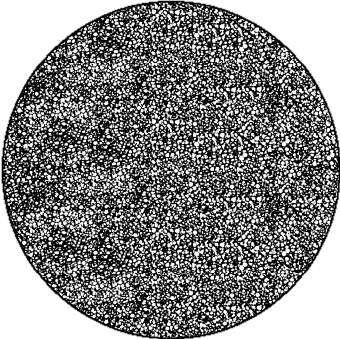





| | |
|--|---|
| M 817 SW | M 818 SW |
|  40mm |  45mm |



| | |
|--|--|
| | |
| | |



Genauere Angaben zu den Farben, Werkstoffen und Abnahmemengen siehe bitte Preisliste. Konstruktionsänderungen an den Querschnitten vorbehalten - Zur Abklärung der Passgenauigkeit bitte vor Bestellung ein 10cm-Muster anfordern. Lieferung ab Warenwert € 40,- netto frei Haus, ansonsten zzgl. € 6,95 netto Fracht. Maßstab: ca. 1:1. Stand 04/14.





Renovierungs-Dichtungen für Stahlzargen





| M 821 SW | M 822 SW | M 823 SW | M 824 SW | M 825 SW | M 826 SW |
|---|---|---|---|---|---|
|  2 x 10mm |  2 x 15mm |  2 x 20mm |  3 x 10mm |  3 x 12mm |  3 x 15mm |



| M 827 SW | M 828 SW | M 829 SW | |
|---|---|--|--|
|  3 x 20mm |  3 x 25mm |  3 x 30mm | |



| M 830 SW | M 831 SW | |
|---|--|--|
|  3 x 40mm |  3 x 50mm | |



| M 744 gr/sw | M 718 gr/sw | M 832 sw | M 709 gr/sw | M 833 sw | |
|--|---|---|---|---|--|
|  4 x 8mm |  4 x 10mm |  4 x 12mm |  4 x 15mm |  4 x 20mm | |

Genauere Angaben zu den Farben, Werkstoffen und Abnahmemengen siehe bitte Preisliste. Konstruktionsänderungen an den Querschnitten vorbehalten - Zur Abklärung der Passgenauigkeit bitte vor Bestellung ein 10cm-Muster anfordern. Lieferung ab Warenwert € 40,- netto frei Haus, ansonsten zzgl. € 6,95 netto Fracht. Maßstab: ca. 1:1. Stand 07/21.





| M 834 sw | M 835 sw | M 836 sw |
|---|---|---|
|  4 x 25mm |  4 x 30mm |  4 x 40mm |



| M 837 sw | | M 751 gr/sw | M 700 gr/sw |
|---|--|---|---|
|  4 x 50mm | |  5 x 10mm |  5 x 15mm |



| M 839 sw | M 840 sw | M 841 sw | |
|---|---|--|--|
|  5 x 20mm |  5 x 25mm |  5 x 30mm | |





| M 842 sw | M 843 sw | |
|---|--|--|
|  5 x 40mm |  5 x 50mm | |

Genauere Angaben zu den Farben, Werkstoffen und Abnahmemengen siehe bitte Preisliste. Konstruktionsänderungen an den Querschnitten vorbehalten - Zur Abklärung der Passgenauigkeit bitte vor Bestellung ein 10cm-Muster anfordern. Lieferung ab Warenwert € 40,- netto frei Haus, ansonsten zzgl. € 6,95 netto Fracht. Maßstab: ca. 1:1. Stand 11/20.

| | | | |
|---|---|---|---|
| M 844 sw | M 752 gr/sw | M 761 sw | M 775 gr/sw |
|  5 x 60mm |  6 x 10mm |  6 x 12mm |  6 x 15mm |

| | | | |
|---|---|--|--|
| M 845 sw | M 846 sw | M 847 sw | |
|  6 x 20mm |  6 x 25mm |  6 x 30mm | |



| | | |
|---|--|---|
| M 848 sw | M 849 sw | M 850 sw |
|  6 x 40mm |  6 x 50mm |  7 x 10mm |





| | | | | | |
|--|---|---|---|---|--|
| M 776 sw | M 762 gr/sw | M 777 sw | M 899 gr/sw | M 851 sw | |
|  8 x 8mm |  8 x 10mm |  8 x 12mm |  8 x 15mm |  8 x 20mm | |



Genauere Angaben zu den Farben, Werkstoffen und Abnahmemengen siehe bitte Preisliste. Konstruktionsänderungen an den Querschnitten vorbehalten - Zur Abklärung der Passgenauigkeit bitte vor Bestellung ein 10cm-Muster anfordern. Lieferung ab Warenwert € 40,- netto frei Haus, ansonsten zzgl. € 6,95 netto Fracht. Maßstab: ca. 1:1. Stand 12/20.

Renovierungs-Dichtungen für Stahlzargen



| | | |
|---|---|---|
| M 773 gr/sw | M 852 sw | M 853 sw |
|  8 x 25mm |  8 x 30mm |  8 x 40mm |

| | | | |
|---|--|--|--|
| M 854 sw | M 749 gr/sw | M 855 sw | M 748 gr/sw |
|  8 x 50mm |  10 x 10mm |  10 x 12mm |  10 x 15mm |





| | | | |
|--|--|---|--|
| M 774 gr/sw | M 856 sw | M 857 sw | |
|  10 x 20mm |  10 x 25mm |  10 x 30mm | |

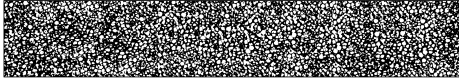

| | | | | |
|--|--|--|--|--|
| M 858 sw | | | | |
|  10 x 35mm | | | | |

Genauere Angaben zu den Farben, Werkstoffen und Abnahmemengen siehe bitte Preisliste. Konstruktionsänderungen an den Querschnitten vorbehalten - Zur Abklärung der Passgenauigkeit bitte vor Bestellung ein 10cm-Muster anfordern. Lieferung ab Warenwert € 40,- netto frei Haus, ansonsten zzgl. € 6,95 netto Fracht. Maßstab: ca. 1:1. Stand 04/14.

| | | |
|--|--|--|
| M 859 sw | | |
|  10 x 40mm | | |

| | |
|--|---|
| M 861 sw | M 862 sw |
|  10 x 50mm |  10 x 60mm |

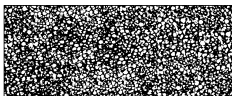
| | | | | |
|--|--|--|---|--|
| M 760 gr/sw | M 863 gr/sw | M 772 gr/sw | M 864 sw | |
|  12 x 12mm |  12 x 15mm |  12 x 20mm |  12 x 25mm | |

| | | |
|--|--|--|
| M 865 sw | M 867 sw | |
|  12 x 30mm |  12 x 40mm | |

Genauere Angaben zu den Farben, Werkstoffen und Abnahmemengen siehe bitte Preisliste. Konstruktionsänderungen an den Querschnitten vorbehalten - Zur Abklärung der Passgenauigkeit bitte vor Bestellung ein 10cm-Muster anfordern. Lieferung ab Warenwert € 40,- netto frei Haus, ansonsten zzgl. € 6,95 netto Fracht. Maßstab: ca. 1:1. Stand 12/20.

Renovierungs-Dichtungen für Stahlzargen

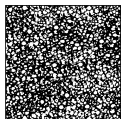
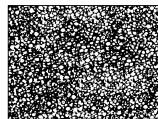

| | | | | | |
|--|--|--|--|--|--|
| M 771 gr/sw | M 745 gr/sw | | | | |
|  15 x 15mm |  15 x 20mm | | | | |

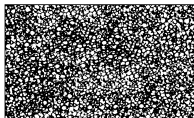
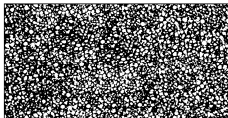
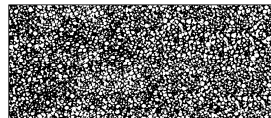
| | | |
|--|--|--|
| M 869 sw | M 870 sw | M 871 sw |
|  15 x 25mm |  15 x 30mm |  15 x 35mm |

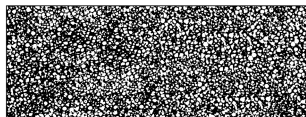
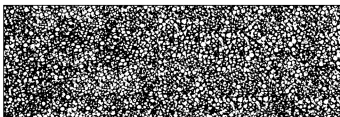
| | | | |
|--|--|--|--|
| M 872 sw | M 873 sw | | |
|  15 x 40mm |  15 x 45mm | | |

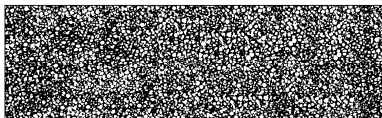
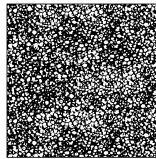
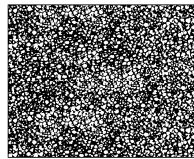
| | | |
|--|--|--|
| M 874 sw | M 875 sw | M 876 sw |
|  15 x 50mm |  20 x 20mm |  20 x 25mm |

Genauere Angaben zu den Farben, Werkstoffen und Abnahmemengen siehe bitte Preisliste. Konstruktionsänderungen an den Querschnitten vorbehalten - Zur Abklärung der Passgenauigkeit bitte vor Bestellung ein 10cm-Muster anfordern. Lieferung ab Warenwert € 40,- netto frei Haus, ansonsten zzgl. € 6,95 netto Fracht. Maßstab: ca. 1:1. Stand 12/20.

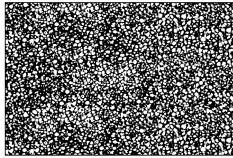
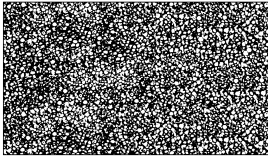
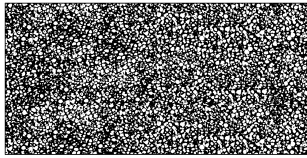
| | | |
|---|---|---|
| M 877 SW | M 878 SW | M 879 SW |
|  |  |  |
| 20 x 30mm | 20 x 35mm | 20 x 40mm |

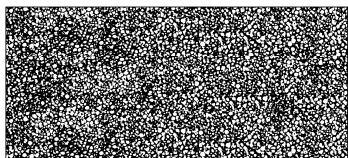
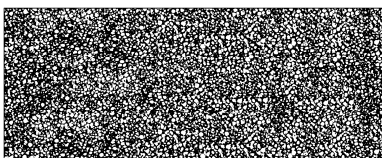
| | | |
|---|--|--|
| M 880 SW | M 881 SW | |
|  |  | |
| 20 x 45mm | 20 x 50mm | |

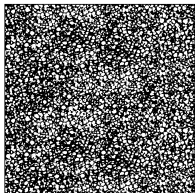
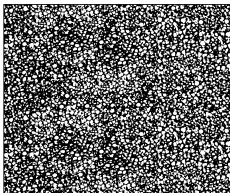
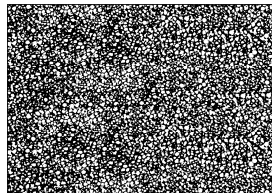
| | | |
|---|---|---|
| M 882 SW | M 883 SW | M 884 SW |
|  |  |  |
| 25 x 25mm | 25 x 30mm | 25 x 35mm |

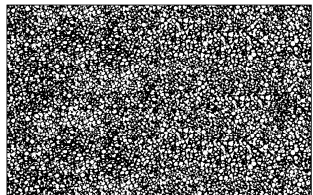
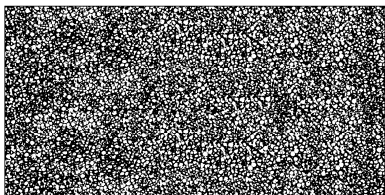
| | | |
|---|--|--|
| M 885 SW | M 887 SW | |
|  |  | |
| 25 x 40mm | 25 x 50mm | |

Genauere Angaben zu den Farben, Werkstoffen und Abnahmemengen siehe bitte Preisliste. Konstruktionsänderungen an den Querschnitten vorbehalten - Zur Abklärung der Passgenauigkeit bitte vor Bestellung ein 10cm-Muster anfordern. Lieferung ab Warenwert € 40,- netto frei Haus, ansonsten zzgl. € 6,95 netto Fracht. Maßstab: ca. 1:1. Stand 12/20.

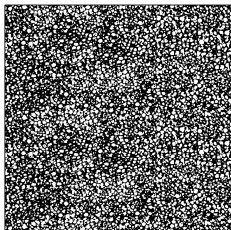
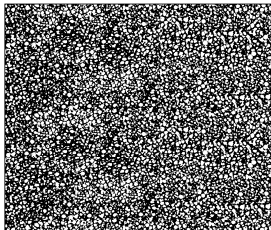
| | |
|--|---|
| <p>M 888 sw</p> | <p>M 889 sw</p> |
|  <p>30 x 30mm</p> |  <p>30 x 35mm</p> |

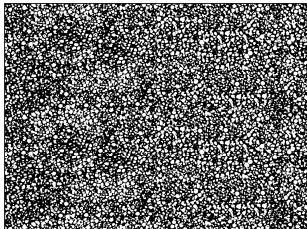
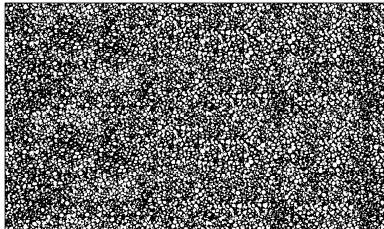

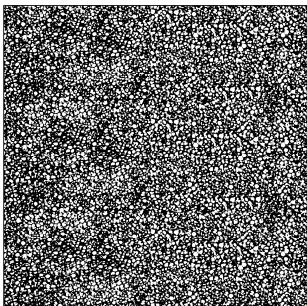
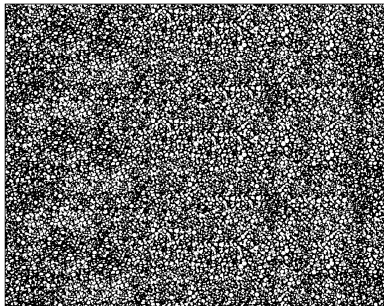

| | |
|---|--|
| <p>M 890 sw</p> | <p>M 892 sw</p> |
|  <p>30 x 40mm</p> |  <p>30 x 50mm</p> |

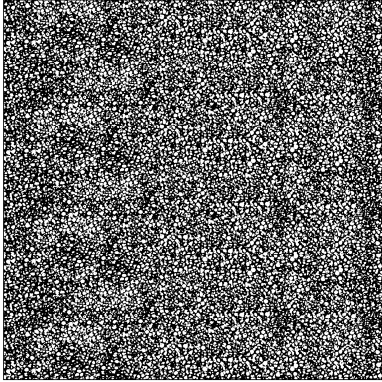



| | |
|--|---|
| <p>M 896 sw</p> | <p>M 897 sw</p> |
|  <p>40 x 40mm</p> |  <p>40 x 50mm</p> |



Genauere Angaben zu den Farben, Werkstoffen und Abnahmemengen siehe bitte Preisliste. Konstruktionsänderungen an den Querschnitten vorbehalten - Zur Abklärung der Passgenauigkeit bitte vor Bestellung ein 10cm-Muster anfordern. Lieferung ab Warenwert € 40,- netto frei Haus, ansonsten zzgl. € 6,95 netto Fracht. Maßstab: ca. 1:1. Stand 12/20.



| M 898 sw | |
|--|--|
|  <p data-bbox="443 909 549 931">50 x 50mm</p> | |

Genauere Angaben zu den Farben, Werkstoffen und Abnahmemengen siehe bitte Preisliste. Konstruktionsänderungen an den Querschnitten vorbehalten - Zur Abklärung der Passgenauigkeit bitte vor Bestellung ein 10cm-Muster anfordern. Lieferung ab Warenwert € 40,- netto frei Haus, ansonsten zzgl. € 6,95 netto Fracht. Maßstab: ca. 1:1. Stand 12/20.

| M 821-SK gr/sw | M 822-SK gr/sw | M 823-SK gr/sw | | M 824-SK gr/sw | |
|---|---|---|--|---|--|
|  2 x 10mm |  2 x 15mm |  2 x 20mm | |  3 x 10mm | |

| M 825-SK sw | M 826-SK gr/sw | M 827-SK gr/sw | M 828-SK sw | |
|---|---|---|--|--|
|  3 x 12mm |  3 x 15mm |  3 x 20mm |  3 x 25mm | |

| M 829-SK gr/sw | M 830-SK gr/sw | | |
|---|---|--|--|
|  3 x 30mm |  3 x 40mm | | |





| M 831-SK gr/sw | | M 718-SK gr/sw | M 832-SK sw |
|---|--|---|---|
|  3 x 50mm | |  4 x 10mm |  4 x 12mm |

Genauere Angaben zu den Farben, Werkstoffen und Abnahmemengen siehe bitte Preisliste. Konstruktionsänderungen an den Querschnitten vorbehalten - Zur Abklärung der Passgenauigkeit bitte vor Bestellung ein 10cm-Muster anfordern. Lieferung ab Warenwert € 40,- netto frei Haus, ansonsten zzgl. € 6,95 netto Fracht. Maßstab: ca. 1:1. Stand 12/20.





Profile als Montagehilfe einseitig selbstklebend auf der Breitseite ausgerüstet



Renovierungs-Dichtungen für Stahlzargen



| M 709-SK gr/sw | M 833-SK gr/sw | M 834-SK sw | M 835-SK gr/sw |
|---|---|---|---|
|  4 x 15mm |  4 x 20mm |  4 x 25mm |  4 x 30mm |

| M 836-SK gr/sw | M 837-SK gr/sw |
|---|--|
|  4 x 40mm |  4 x 50mm |

| | M 751-SK gr/sw | M 700-SK sw | M 839-SK gr/sw | M 840-SK gr/sw |
|--|---|---|---|---|
| |  5 x 10mm |  5 x 15mm |  5 x 20mm |  5 x 25mm |



| M 841-SK gr/sw | M 842-SK gr/sw |
|---|---|
|  5 x 30mm |  5 x 40mm |





Genauere Angaben zu den Farben, Werkstoffen und Abnahmemengen siehe bitte Preisliste. Konstruktionsänderungen an den Querschnitten vorbehalten - Zur Abklärung der Passgenauigkeit bitte vor Bestellung ein 10cm-Muster anfordern. Lieferung ab Warenwert € 40,- netto frei Haus, ansonsten zzgl. € 6,95 netto Fracht. Maßstab: ca. 1:1. Stand 11/20.



Profile als Montagehilfe einseitig selbstklebend auf der Breitseite ausgerüstet

Renovierungs-Dichtungen für Stahlzargen



| | |
|---|--|
| M 843-SK sw | M 844-SK sw |
|  5 x 50mm |  5 x 60mm |

| | | | | |
|---|---|---|---|---|
| M 752-SK gr/sw | M 761-SK sw | M 775-SK gr/sw | M 845-SK gr/sw | M 846-SK sw |
|  6 x 10mm |  6 x 12mm |  6 x 15mm |  6 x 20mm |  6 x 25mm |

| | | | |
|---|---|--|--|
| M 847-SK sw | M 848-SK sw | | |
|  6 x 30mm |  6 x 40mm | | |





| | | | |
|---|--|--|--|
| M 849-SK sw | | | |
|  6 x 50mm | | | |



Genauere Angaben zu den Farben, Werkstoffen und Abnahmemengen siehe bitte Preisliste. Konstruktionsänderungen an den Querschnitten vorbehalten - Zur Abklärung der Passgenauigkeit bitte vor Bestellung ein 10cm-Muster anfordern. Lieferung ab Warenwert € 40,- netto frei Haus, ansonsten zzgl. € 6,95 netto Fracht. Maßstab: ca. 1:1. Stand 12/20.





Profile als Montagehilfe einseitig selbstklebend auf der Breitseite ausgerüstet



Renovierungs-Dichtungen für Stahlzargen



| | M 776-SK sw | M 762-SK gr/sw | M 777-SK sw | M 851-SK gr/sw | |
|--|--|---|---|---|--|
| |  8 x 8mm |  8 x 10mm |  8 x 12mm |  8 x 20mm | |



| M 773-SK gr/sw | M 852-SK gr/sw | M 853-SK sw |
|---|---|---|
|  8 x 25mm |  8 x 30mm |  8 x 40mm |



| M 854-SK sw | M 749-SK gr/sw | M 855-SK sw | M 748-SK gr/sw |
|---|--|--|--|
|  8 x 50mm |  10 x 10mm |  10 x 12mm |  10 x 15mm |

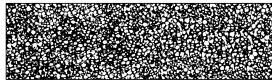

| M 774-SK gr/sw | M 856-SK gr/sw | M 857-SK gr/sw | |
|--|--|---|--|
|  10 x 20mm |  10 x 25mm |  10 x 30mm | |

Genauere Angaben zu den Farben, Werkstoffen und Abnahmemengen siehe bitte Preisliste. Konstruktionsänderungen an den Querschnitten vorbehalten - Zur Abklärung der Passgenauigkeit bitte vor Bestellung ein 10cm-Muster anfordern. Lieferung ab Warenwert € 40,- netto frei Haus, ansonsten zzgl. € 6,95 netto Fracht. Maßstab: ca. 1:1. Stand 12/20.

Profile als Montagehilfe einseitig selbstklebend auf der Breitseite ausgerüstet

| | | |
|--|--|--|
| M 858-SK sw | M 859-SK gr/sw | |
|  10 x 35mm |  10 x 40mm | |

| | |
|--|---|
| M 861-SK gr/sw | M 862-SK sw |
|  10 x 50mm |  10 x 60mm |

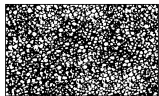
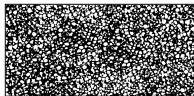
| | | | | |
|--|--|--|---|--|
| M 760-SK gr/sw | M 863-SK gr/sw | M 772-SK gr/sw | M 864-SK sw | |
|  12 x 12mm |  12 x 15mm |  12 x 20mm |  12 x 25mm | |

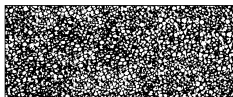
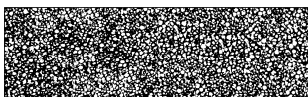
| | | | |
|--|--|--|--|
| M 865-SK sw | M 867-SK sw | | |
|  12 x 30mm |  12 x 40mm | | |

Genauere Angaben zu den Farben, Werkstoffen und Abnahmemengen siehe bitte Preisliste. Konstruktionsänderungen an den Querschnitten vorbehalten - Zur Abklärung der Passgenauigkeit bitte vor Bestellung ein 10cm-Muster anfordern. Lieferung ab Warenwert € 40,- netto frei Haus, ansonsten zzgl. € 6,95 netto Fracht. Maßstab: ca. 1:1. Stand 12/20.

Profile als Montagehilfe einseitig selbstklebend auf der Breitseite ausgerüstet

Renovierungs-Dichtungen für Stahlzargen

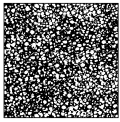
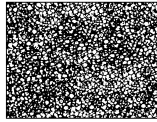

| | | | | | |
|--|--|--|--|--|--|
| M 771-SK gr/sw | M 745-SK gr/sw | | | | |
|  15 x 15mm |  15 x 20mm | | | | |

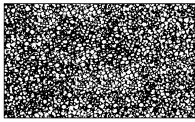
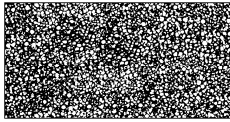
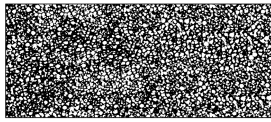
| | | |
|--|--|--|
| M 869-SK sw | M 870-SK gr/sw | M 871-SK sw |
|  15 x 25mm |  15 x 30mm |  15 x 35mm |

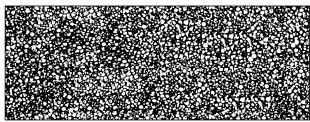
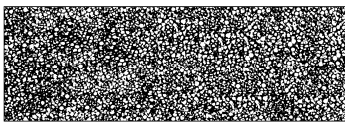
| | | | |
|--|--|--|--|
| M 872-SK gr/sw | M 873-SK sw | | |
|  15 x 40mm |  15 x 45mm | | |

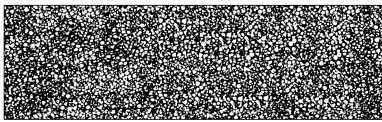
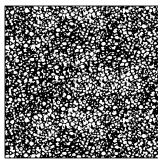
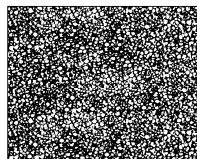
| | | |
|--|--|--|
| M 874-SK sw | M 875-SK gr/sw | M 876-SK gr/sw |
|  15 x 50mm |  20 x 20mm |  20 x 25mm |

Genauere Angaben zu den Farben, Werkstoffen und Abnahmemengen siehe bitte Preisliste. Konstruktionsänderungen an den Querschnitten vorbehalten - Zur Abklärung der Passgenauigkeit bitte vor Bestellung ein 10cm-Muster anfordern. Lieferung ab Warenwert € 40,- netto frei Haus, ansonsten zzgl. € 6,95 netto Fracht. Maßstab: ca. 1:1. Stand 12/20.

Profile als Montagehilfe einseitig selbstklebend auf der Breitseite ausgerüstet

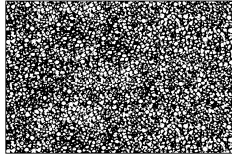
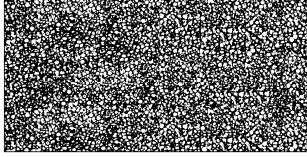
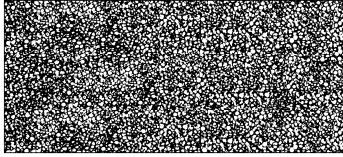
| | | |
|---|---|---|
| M 877-SK gr/sw | M 879-SK gr/sw | M 880-SK sw |
|  |  |  |
| 20 x 30mm | 20 x 40mm | 20 x 45mm |

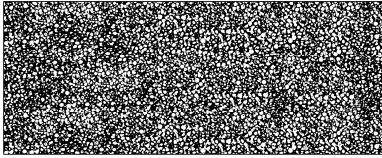
| | |
|---|--|
| M 881-SK sw | |
|  | |
| 20 x 50mm | |

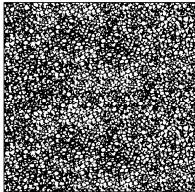
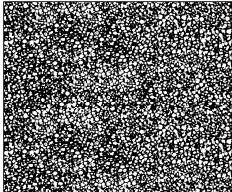
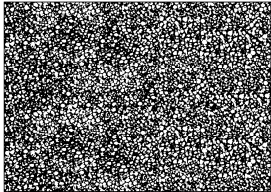
| | | |
|---|---|---|
| M 882-SK gr/sw | M 883-SK sw | M 884-SK sw |
|  |  |  |
| 25 x 25mm | 25 x 30mm | 25 x 35mm |

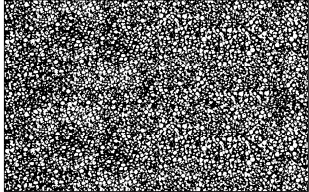
| | | |
|---|--|--|
| M 885-SK sw | | |
|  | | |
| 25 x 40mm | | |

Genauere Angaben zu den Farben, Werkstoffen und Abnahmemengen siehe bitte Preisliste. Konstruktionsänderungen an den Querschnitten vorbehalten - Zur Abklärung der Passgenauigkeit bitte vor Bestellung ein 10cm-Muster anfordern. Lieferung ab Warenwert € 40,- netto frei Haus, ansonsten zzgl. € 6,95 netto Fracht. Maßstab: ca. 1:1. Stand 12/20.

Profile als Montagehilfe einseitig selbstklebend auf der Breitseite ausgerüstet

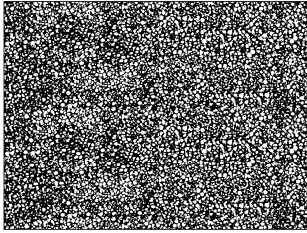





| | |
|--|--|
| M 890-SK SW | |
|  30 x 40mm | |







| | |
|--|--|
| | |
| | |







| | |
|--|--|
| | |
| | |





Genauere Angaben zu den Farben, Werkstoffen und Abnahmemengen siehe bitte Preisliste. Konstruktionsänderungen an den Querschnitten vorbehalten - Zur Abklärung der Passgenauigkeit bitte vor Bestellung ein 10cm-Muster anfordern. Lieferung ab Warenwert € 40,- netto frei Haus, ansonsten zzgl. € 6,95 netto Fracht. Maßstab: ca. 1:1. Stand 12/20.

Profile als Montagehilfe einseitig selbstklebend auf der Breitseite ausgerüstet







| | | | | | |
|---|---|---|---|---|---|
| R 2336 br/sw/w | R 1143 w | R 906 w | R 1311 w | R 1343 br/w | R 532 sw |
|  |  |  |  |  |  |
| 10mm Falz 2,8mm Nut | 10mm Falz 3mm Nut | 10mm Falz 4mm Nut | 10mm Falz 4mm Nut | 2,5mm Nut | 4mm Nut |

| | | | | | |
|---|---|---|---|---|---|
| R 934 br/gr/w | RT 1 be/br/gr/sw/w | RT 1-B w | RT 5 be/br/gr/sw/w | Bei der RT 5 lassen sich 1 bis 2 Fußlippen durch abziehen entfernen | |
|  |  |  |  |  |  |
| 11mm Falz 4mm Nut | 12mm Falz 4mm Nut | 12mm Falz 4mm Nut | 11 bis 12mm Falz 4mm Nut Lieferung immer in dieser Ausführung | mit entfernter unterer Fußlippe passend für 2,8 bis 3,2mm Nut | mit entfernter unterer und mittlerer Fußlippe passend für 2,2mm Nut |

| | | | | | |
|---|---|---|---|---|---|
| R 911 br/sw/w | R 911-A br/sw/w | RT 4 be/br/gr/sw/w | R 919 w | R 909 br/w | R 2305 be |
|  |  |  |  |  |  |
| 12mm Falz 4mm Nut | 11mm Falz 4mm Nut | 12mm Falz 4mm Nut | 12mm Falz 4mm Nut | 12mm Falz 4mm Nut | 12mm Falz 4mm Nut |

| | | | | | |
|---|---|--|---|---|---|
| RT 2 be/br/gr/sw/w | RT 2-B w | | RT 3 be/br/w | R 9501 br/w | R 996 be/br/sw/w |
|  |  | |  |  |  |
| 12mm Falz 4mm Nut | 12mm Falz 4mm Nut | | 12mm Falz 4mm Nut | 12mm Falz 4mm Nut | 12mm Falz 4mm Nut |

Genauere Angaben zu den Farben, Werkstoffen und Abnahmemengen siehe bitte Preisliste. Konstruktionsänderungen an den Querschnitten vorbehalten - Zur Abklärung der Passgenauigkeit bitte vor Bestellung ein 10cm-Muster anfordern. Lieferung ab Warenwert € 40,- netto frei Haus, ansonsten zzgl. € 6,95 netto Fracht. Maßstab: ca. 1:1. Stand 06/23.





| R 902 br/w | R 910 w | R 923 br/gr/sw/w | R 1115 br/sw/w | R 1062 br/w | R 8547 be/br/w |
|---|---|---|---|---|---|
|  |  |  |  |  |  |
| 12mm Falz 4mm Nut | 12mm Falz 4mm Nut | 12mm Falz 4mm Nut | 11mm Falz 4mm Nut | 12mm Falz 4mm Nut | 12mm Falz 3,5mm Nut |







| | | | | | |
|--|--|--|--|--|--|
| | | | | | |
| | | | | | |







| | R 5768 | | | | |
|--|---|--|--|--|--|
| |  | | | | |







| | | | | R 5605 w | |
|--|--|--|--|---|--|
| | | | |  | |

Genauere Angaben zu den Farben, Werkstoffen und Abnahmemengen siehe bitte Preisliste. Konstruktionsänderungen an den Querschnitten vorbehalten - Zur Abklärung der Passgenauigkeit bitte vor Bestellung ein 10cm-Muster anfordern. Lieferung ab Warenwert € 40,- netto frei Haus, ansonsten zzgl. € 6,95 netto Fracht. Maßstab: ca. 1:1. Stand 05/23.







| | | | | | |
|---|--|---|---|---|---|
| R 1927 br/gr/sw/w | | R 1523 br/w | R 915 be/br/gr/sw/w | R 915-A be/br/gr/sw/w | R 915-B br/sw/w |
|  | |  |  |  |  |
| 12mm Falz 2,8mm Nut | | 12mm Falz 3mm Nut | 12mm Falz 2,8mm Nut | 11mm Falz 2,8mm Nut | 2,8mm Nut mit Ausreißsteg |







| | | | | | |
|---|---|---|---|---|---|
| R 2017 br/w | R 1231 be/br/gr/w | R 940 be/br/gr/sw/w | R 927 be/br/gr/sw/w | R 927-A be/br/w | R 927-B w |
|  |  |  |  |  |  |
| 12mm Falz 3mm Nut | 12mm Falz 2,8mm Nut | 12mm Falz 2,8mm Nut | 12mm Falz 2,8mm Nut | 12mm Falz 2,2mm Nut | 12mm Falz 2,8mm Nut |







| | | | | | |
|---|---|---|---|---|---|
| R 924 br/w | R 925 | R 939 br/w | R 931 br/w | R 1499 w | R 1046 be/w |
|  |  |  |  |  |  |
| 12mm Falz 2,8mm Nut | 12mm Falz 3,5mm Nut | 3,2mm Nut | 12mm Falz 2,8mm Nut | 12mm Falz 3mm Nut | 12mm Falz 3mm Nut |





| | | | | | |
|---|---|---|---|---|---|
| R 926 br/w | R 5799 w | R 917 w | R 937 gr | R 8628 be/w | |
|  |  |  |  |  |  |
| 12mm Falz 4mm Nut | | 12m Falz 4mm Nut | 12mm Falz 4,5mm Nut | ersetzt durch R 8628 | verbesserte Version |

Genauere Angaben zu den Farben, Werkstoffen und Abnahmemengen siehe bitte Preisliste. Konstruktionsänderungen an den Querschnitten vorbehalten - Zur Abklärung der Passgenauigkeit bitte vor Bestellung ein 10cm-Muster anfordern. Lieferung ab Warenwert € 40,- netto frei Haus, ansonsten zzgl. € 6,95 netto Fracht. Maßstab: ca. 1:1. Stand 12/22.



| | | | | | |
|---|---|---|---|---|---|
| R 1904 br/w | R 914 br/w | R 942-A w | R 905 br/w | R 1908 be/br/w | R 904 br/w |
|  |  |  |  |  |  |
| 14mm Falz 4mm Nut | 14mm Falz 4mm Nut | 14mm Falz 4mm Nut | 14mm Falz 4mm Nut | 14mm Falz 4mm Nut | 14mm Falz 4mm Nut |





| | | | | | |
|---|---|---|---|---|---|
| R 935 sw | R 938 gr | R 9502 br/w | R 8807 w | R 5719 w | R 8936 be/br/w |
|  |  |  |  |  |  |



| | | | | | |
|---|---|---|---|---|---|
| R 8615 | R 8956 gr | R 2145 br/w | R 1262 w | R 1916 w | R 9572 sw/w |
|  |  |  |  |  |  |
| | | | 2,8mm Nut | 16mm Falz 4mm Nut | |



| | | | | | |
|---|---|---|---|---|--|
| R 918 tr | R 932 tr | R 932 sw | R 920 tr | R 950 | |
|  |  |  |  |  | |
| PVC | PVC | TPE | PVC | PVC | |

Genauere Angaben zu den Farben, Werkstoffen und Abnahmemengen siehe bitte Preisliste. Konstruktionsänderungen an den Querschnitten vorbehalten - Zur Abklärung der Passgenauigkeit bitte vor Bestellung ein 10cm-Muster anfordern. Lieferung ab Warenwert € 40,- netto frei Haus, ansonsten zzgl. € 6,95 netto Fracht. Maßstab: ca. 1:1. Stand 09/23.



| | | | | | |
|--|---|--|---|--|--|
| | R 5519 w | | R 5625 w | | |
| |  | |  | | |







| | | | | | |
|--|---|--|---|--|---|
| R 5525 gr/w | R 5538 gr | | R 5515 w | | R 5575 sw/w |
|  3,5mm Nut |  | |  | |  15mm Falz 4mm Nut |





| | | | | | |
|--|---|--|---|--|---|
| | R 5624 sw/w | | R 5815 w | | R 1016 sw |
| |  | |  15mm Falz 4mm Nut | |  |



| | | | | | |
|---|--|---|--|---|--|
| R 3058 sw | | R 5551 w | | R 5678 sw | |
|  | |  | |  | |

Genauere Angaben zu den Farben, Werkstoffen und Abnahmemengen siehe bitte Preisliste. Konstruktionsänderungen an den Querschnitten vorbehalten - Zur Abklärung der Passgenauigkeit bitte vor Bestellung ein 10cm-Muster anfordern. Lieferung ab Warenwert € 40,- netto frei Haus, ansonsten zzgl. € 6,95 netto Fracht. Maßstab: ca. 1:1. Stand 09/23.



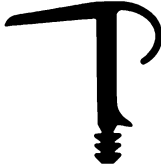

| | | | | | |
|---|--|--|---|--|---|
| R 986 sw | | | R 900 | | R 1565 gr |
|  | | |  | |  |





| | | | | | |
|---|---|---|---|---|--|
| R 1227 sw | R 527 tr | R 527-B tr | R 1449 | R 2061 | R 968 sw |
|  |  |  |  |  |  |



| | | | | | |
|---|---|---|--|---|---|
| R 2521 sw | R 1407 | R 2504 | | R 1803 sw | R 8537 sw |
|  |  |  | |  |  |

| | | | | | |
|--|--|--|---|--|---|
| | | | R 1990 w | | R 892 sw |
| | | |  | |  |

Genauere Angaben zu den Farben, Werkstoffen und Abnahmemengen siehe bitte Preisliste. Konstruktionsänderungen an den Querschnitten vorbehalten - Zur Abklärung der Passgenauigkeit bitte vor Bestellung ein 10cm-Muster anfordern. Lieferung ab Warenwert € 40,- netto frei Haus, ansonsten zzgl. € 6,95 netto Fracht. Maßstab: ca. 1:1. Stand 06/24.





| RF 2 be/br/gr/sw/w | R 715 sw | R 641 sw | RÜ 1250 sw | Silikon H12 be/br/ggr/zg/rbr/sw/w |
|---|---|---|---|--|
|  12mm Falz 5mm Nut |  12mm Falz 5mm Nut |  12mm Falz 5mm Nut |  12mm Falz 5mm Nut |  12mm Falz 4-5mm Nut 10mm Kopfbreite Silikon mit Faden Klasse W 45276 |





| RF 3 be/br/gr/rbr/sw/w | RFÜ 3 sw/w | RF 12 sw | RF 1 sw/w | FSW 1245 an/be/br/gr/sw/w |
|---|---|---|---|---|
|  12mm Falz 5mm Nut |  12mm Falz 5mm Nut |  12mm Falz 5mm Nut |  12mm Falz 5mm Nut |  12mm Falz 4-4,5-5,0mm Nut 9mm Kopfbreite Rücken hart Kopf weich Fußlippen weich = Superweich ! |



| F 125 (3 Komponenten-Profil) be/br/sw/w | FSW 125 (Silikon-Ersatzdichtg.) be/br/gr/sw/w |
|---|---|
|  12mm Falz 5mm Nut 8,5mm Kopfbreite Rücken hart Kopf weich Fußlippen weich Klasse W35243 |  12mm Falz 5mm Nut 9mm Kopfbreite Rücken hart Kopf weich Fußlippen weich Klasse W34245 = Superweich ! |



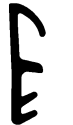
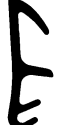

| RF 23 sw | FSW 103 (Silikon-Ersatzdichtg.) br/gr/sw/w | FSW 123 (Silikon-Ersatzdichtg.) be/br/gr/sw/w |
|---|--|--|
|  12mm Falz 5mm Nut |  10mm Falz 3mm Nut 8,5mm Kopfbreite Rücken hart Kopf weich Fußlippen weich Klasse W35245 (W33255) = Superweich ! |  12mm Falz 3mm Nut 8,5mm Kopfbreite Rücken hart Kopf weich Fußlippen weich Klasse W35245 (W34255) = Superweich ! |

Genauere Angaben zu den Farben, Werkstoffen und Abnahmemengen siehe bitte Preisliste. Konstruktionsänderungen an den Querschnitten vorbehalten - Zur Abklärung der Passgenauigkeit bitte vor Bestellung ein 10cm-Muster anfordern. Lieferung ab Warenwert € 40,- netto frei Haus, ansonsten zzgl. € 6,95 netto Fracht. Maßstab: ca. 1:1. Stand 06/24.



| | | | | | |
|---|---|---|---|--|--|
| RF 9 br/sw/w | RF 10 br/sw/w | R 8920 br/sw/w | R 2303 sw | | |
|  |  |  |  | | |
| 12mm Falz 4mm Nut | 12mm Falz 4mm Nut | 12mm Falz 4mm Nut | 12mm Falz 4mm Nut | | |

| | | | | | |
|---|---|---|--|---|---|
| RF 13 br/sw | RF 7 sw | RF 21 sw | | RF 24 sw/w | RF 11 br/sw/w |
|  |  |  | |  |  |
| 10mm Falz 4mm Nut | 10mm Falz 4mm Nut | 10mm Falz 4mm Nut | | 10mm Falz 5mm Nut | 10mm Falz 5mm Nut |

| | | | | | |
|--|---|---|---|---|---|
| | R 1340 br/w | R 1430 sw/w | R 883 sw/w | RF 8 sw/w | R 2030 br/w |
| |  |  |  |  |  |
| | 8mm Falz 4mm Nut | 9mm Falz 3mm Nut | 10mm Falz 3,5mm Nut | 12mm Falz 3mm Nut | 15mm Falz 3mm Nut |

| | | | | | |
|---|--|---|--|---|---|
| R 1950 sw | | R 1540 sw | | R 1542 gr | R 2198 sw |
|  | |  | |  |  |
| 14mm Falz 5mm Nut | | 15mm Falz 4mm Nut | | 10mm Falz 3mm Nut | |





Genauere Angaben zu den Farben, Werkstoffen und Abnahmemengen siehe bitte Preisliste. Konstruktionsänderungen an den Querschnitten vorbehalten - Zur Abklärung der Passgenauigkeit bitte vor Bestellung ein 10cm-Muster anfordern. Lieferung ab Warenwert € 40,- netto frei Haus, ansonsten zzgl. € 6,95 netto Fracht. Maßstab: ca. 1:1. Stand 12/20.



| R 2050 sw/w | RF 4 rbr/sw/w | Silikon H15 be/br/ggr/zg/rbr/sw/w | FSW 155 (Silikon-Ersatzdichtg.) be/gr/rbr/sw/w |
|---|---|--|---|
|  15mm Falz 5mm Nut |  15mm Falz 5mm Nut |  15mm Falz 4-5mm Nut 10mm Kopfbreite Silikon mit Faden Klasse W 45276 |  15mm Falz 5mm Nut 9mm Kopfbreite Rücken hart Kopf weich Fußlippen weich Klasse W35255 = Superweich ! |

| | | | | | R 2240 sw |
|--|--|--|--|--|---|
| | | | | |  17mm Falz 4mm Nut |

| R 1840 sw | RF 5 br/sw/w | Silikon H18 be/br/ggr/zg/rbr/sw/w | FSW 185 (Silikon-Ersatzdichtg.) be/gr/rbr/sw/w |
|---|---|--|---|
|  18mm Falz 4mm Nut |  18mm Falz 5mm Nut |  18mm Falz 4-5mm Nut 10mm Kopfbreite Silikon mit Faden Klasse W 45276 |  18mm Falz 5mm Nut 9mm Kopfbreite Rücken hart Kopf weich Fußlippen weich Klasse W44245 = Superweich ! |

Genauere Angaben zu den Farben, Werkstoffen und Abnahmemengen siehe bitte Preisliste. Konstruktionsänderungen an den Querschnitten vorbehalten - Zur Abklärung der Passgenauigkeit bitte vor Bestellung ein 10cm-Muster anfordern. Lieferung ab Warenwert € 40,- netto frei Haus, ansonsten zzgl. € 6,95 netto Fracht. Maßstab: ca. 1:1. Stand 12/20.



| | | | | | |
|---|---|---|---|--|--|
| RF 14 br/sw/w | R 2040 sw | R 2340 sw | RF 19 sw | | |
|  |  |  |  | | |
| 15/18mm Falz 5mm Nut | 15mm Falz 4mm Nut | 18mm Falz 4mm Nut | 20mm Falz 4mm Nut | | |



| | | | | | |
|--|--|--|--|---|---|
| | | | | R 2041 br/sw/w | R 2341 sw |
| | | | |  |  |
| | | | | 15mm Falz 4mm Nut | 18mm Falz 4mm Nut |





| | | | | | |
|--|---|--|--|--|--|
| | R 5666 sw/w | | | | |
| |  | | | | |
| | Steg "nicht" ausreißbar aus Funktionsgründen | | | | |

| | | | | | |
|--|--|--|--|--|--|
| | | | | | |
| | | | | | |

Genauere Angaben zu den Farben, Werkstoffen und Abnahmemengen siehe bitte Preisliste. Konstruktionsänderungen an den Querschnitten vorbehalten - Zur Abklärung der Passgenauigkeit bitte vor Bestellung ein 10cm-Muster anfordern. Lieferung ab Warenwert € 40,- netto frei Haus, ansonsten zzgl. € 6,95 netto Fracht. Maßstab: ca. 1:1. Stand 09/20.







| | | | | | |
|--|--|--|---|---|--|
| | R 642 sw | | R 1599 sw/w | R 2335 sw | |
| |  5mm Nut | |  |  | |







| | | | | | |
|--|--|--|--|--|--|
| R 1084 sw | | R 2564 sw | | | |
|  | |  | | | |







| | | | | | |
|--|--|--|--|--|--|
| | | R 1737 | R 548 tr | R 1111 tr | R 1992 br |
| | |  4mm Nut |  4,5mm Nut |  5mm Nut |  5mm Nut |





| | | | | | |
|--|---|--|--|--|--|
| | R 5782 gr | | | | |
| |  | | | | |

Genauere Angaben zu den Farben, Werkstoffen und Abnahmemengen siehe bitte Preisliste. Konstruktionsänderungen an den Querschnitten vorbehalten - Zur Abklärung der Passgenauigkeit bitte vor Bestellung ein 10cm-Muster anfordern. Lieferung ab Warenwert € 40,- netto frei Haus, ansonsten zzgl. € 6,95 netto Fracht. Maßstab: ca. 1:1. Stand 07/23.







| | | | | | |
|--|--|--|--|--|--|
| R 1935 sw | R 1936 | R 1936-A br/sw/w | R 1169 | R 2502 sw/w | R 2519 sw/w |
|  3mm Nut |  3mm Nut |  3mm Nut |  3,5mm Nut |  3mm Nut |  3mm Nut |







| | | | | | |
|--|--|--|--|---|---|
| R 2505 br/sw/w | R 2115 | R 1498 br | R 1814 sw | F 30 sw/w | R 2134 sw |
|  3mm Nut |  3mm Nut |  2,5mm Nut |  2,5mm Nut |  3mm Nut Klasse W34241 |  |







| | | | | | |
|---|---|---|---|---|---|
| R 669 gr | R 5579 sw | R 1173 | R 972 sw | R 941 sw | R 1802 sw |
|  |  |  |  |  |  |







| | | | | | |
|--|---|--|---|---|---|
| | R 8750 sw | | R 8782 be/sw | R 974 br | R 1496 w/br |
| |  | |  |  |  |

Genauere Angaben zu den Farben, Werkstoffen und Abnahmemengen siehe bitte Preisliste. Konstruktionsänderungen an den Querschnitten vorbehalten - Zur Abklärung der Passgenauigkeit bitte vor Bestellung ein 10cm-Muster anfordern. Lieferung ab Warenwert € 40,- netto frei Haus, ansonsten zzgl. € 6,95 netto Fracht. Maßstab: ca. 1:1. Stand 07/23.







| | | | | | |
|---|---|---|---|---|---|
| RF 18 sw | RF 25 sw | RF 26 sw | RF 17 sw | RF 15 sw | R 1452 |
|  |  |  |  |  |  |
| 13mm Falz 5mm Nut | 15mm Falz 5mm Nut | 18mm Falz 5mm Nut | 19mm Falz 5mm Nut | 20mm Falz 4mm Nut | |



| | | | | | |
|---|---|---|--|---|--|
| R 722 | R 522 w | R 662 | R 1815 sw | R 795 sw | R 8624 gr |
|  |  |  |  |  |  |







| | | | | | |
|---|---|---|---|---|---|
| R 834 | R 2001 sw | R 1998 | R 1777 sw | R 590 | R 646 sw |
|  |  |  |  |  |  |

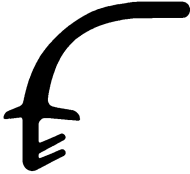



| | | | | | |
|---|---|---|---|---|---|
| R 1461 | R 515 sw | R 502 | R 586 sw | R 558 tr | R 576 w |
|  |  |  |  |  |  |

Genauere Angaben zu den Farben, Werkstoffen und Abnahmemengen siehe bitte Preisliste. Konstruktionsänderungen an den Querschnitten vorbehalten - Zur Abklärung der Passgenauigkeit bitte vor Bestellung ein 10cm-Muster anfordern. Lieferung ab Warenwert € 40,- netto frei Haus, ansonsten zzgl. € 6,95 netto Fracht. Maßstab: ca. 1:1. Stand 07/23.







| | | | | | |
|---|---|---|---|---|---|
| R 1481 sw | R 8781 gr | R 8836 sw | R 971 sw | R 971-A sw | R 971-B sw |
|  |  |  |  |  |  |



| | | | | |
|--|---|--|--|--|
| | R 565 w | R 2106 sw | R 1107 sw | R 945 |
| |  |  |  |  |





| | | | | | |
|---|---|---|---|---|---|
| R 1097 | R 8657 sw | R 8723 sw | R 5652 sw | R 8675 sw | R 8689 sw |
|  |  |  |  |  |  |

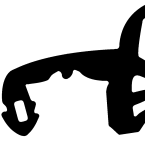



| | | | | | |
|---|---|---|---|--|---|
| R 8934 | R 8935 | R 973 sw | R 1957 sw | | R 8803 sw |
|  |  |  |  | |  |

Genauere Angaben zu den Farben, Werkstoffen und Abnahmemengen siehe bitte Preisliste. Konstruktionsänderungen an den Querschnitten vorbehalten - Zur Abklärung der Passgenauigkeit bitte vor Bestellung ein 10cm-Muster anfordern. Lieferung ab Warenwert € 40,- netto frei Haus, ansonsten zzgl. € 6,95 netto Fracht. Maßstab: ca. 1:1. Stand 09/20.







| | | | | | |
|---|---|---|---|---|---|
| R 903 SW | R 8634 SW | R 1584 SW | R 8610 | R 5690 SW | R 1830 SW |
|  |  |  |  |  |  |







| | | | |
|--|--|--|--|
| R 5761 SW | R 8845 SW | R 5637 SW | R 5599 SW |
|  |  |  |  |







| | | | | | |
|---|---|--|---|--|---|
| R 810 SW | R 865 SW | | R 5667 | | R 8982 |
|  |  | |  | |  |



| | | | | | |
|--|---|---|---|--|---|
| | R 1963 SW | R 1432 SW | R 2036 | | R 9561 SW |
| |  |  |  | |  |

Genauere Angaben zu den Farben, Werkstoffen und Abnahmemengen siehe bitte Preisliste. Konstruktionsänderungen an den Querschnitten vorbehalten - Zur Abklärung der Passgenauigkeit bitte vor Bestellung ein 10cm-Muster anfordern. Lieferung ab Warenwert € 40,- netto frei Haus, ansonsten zzgl. € 6,95 netto Fracht. Maßstab: ca. 1:1. Stand 10/23.







| | | | | | |
|---|---|---|---|---|---|
| R 749 sw | R 516 | R 8998 | R 1473 | R 1043 | R 591 sw |
|  |  |  |  |  |  |





| | | | | | |
|---|---|---|---|---|---|
| R 1444 gr | R 1187 sw | R 729 | R 1987 | R 1047 sw | R 8761 |
|  |  |  |  |  |  |



| | | | | | |
|---|---|---|---|---|---|
| R 1463 sw | R 8621 gr | R 2450 sw | R 8879 | R 2539 | R 2122 sw |
|  |  |  |  |  |  |





| | | | | | |
|---|---|--|--|--|---|
| R 572 tr | R 639 | | | | R 5544 |
|  |  | | | |  |

Genauere Angaben zu den Farben, Werkstoffen und Abnahmemengen siehe bitte Preisliste. Konstruktionsänderungen an den Querschnitten vorbehalten - Zur Abklärung der Passgenauigkeit bitte vor Bestellung ein 10cm-Muster anfordern. Lieferung ab Warenwert € 40,- netto frei Haus, ansonsten zzgl. € 6,95 netto Fracht. Maßstab: ca. 1:1. Stand 06/24.





| | | | | | |
|---|---|---|---|---|---|
| R 1282 SW | R 600 SW | R 1109 SW | R 2346 SW | R 847 | R 1843 |
|  |  |  |  |  |  |

| | | | | | |
|--|--|---|---|---|---|
| | | R 1112 SW | R 2048 SW | R 1150 | R 8528 SW |
| | |  |  |  |  |

| | | | | | |
|--|---|--|--|--|---|
| | R 8510 SW | | | | R 1176 SW |
| |  | | | |  |

| | | | | | |
|---|---|---|---|---|--|
| R 8732 SW | R 1956 SW | R 8630 SW | R 970 SW | R 602 | |
|  |  |  |  |  | |

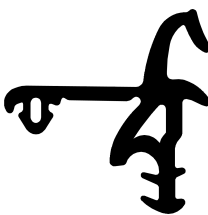

Genauere Angaben zu den Farben, Werkstoffen und Abnahmemengen siehe bitte Preisliste. Konstruktionsänderungen an den Querschnitten vorbehalten - Zur Abklärung der Passgenauigkeit bitte vor Bestellung ein 10cm-Muster anfordern. Lieferung ab Warenwert € 40,- netto frei Haus, ansonsten zzgl. € 6,95 netto Fracht. Maßstab: ca. 1:1. Stand 10/22.

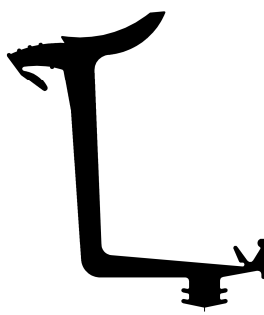

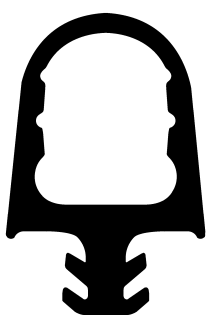
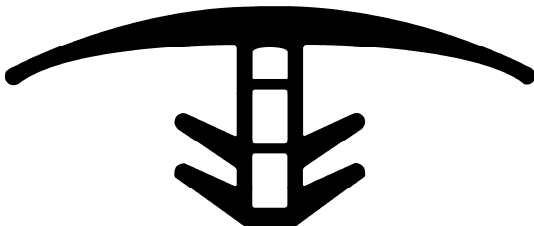
| R 1350 SW | R 5651 SW | R 2130 SW | R 5529 SW |
|---|---|--|---|
|  |  |  |  |

| | R 5805 SW | | |
|--|--|--|--|
| |  | | |



| R 9540 SW | | R 9565 |
|---|--|--|
|  | |  |

Genauere Angaben zu den Farben, Werkstoffen und Abnahmemengen siehe bitte Preisliste. Konstruktionsänderungen an den Querschnitten vorbehalten - Zur Abklärung der Passgenauigkeit bitte vor Bestellung ein 10cm-Muster anfordern. Lieferung ab Warenwert € 40,- netto frei Haus, ansonsten zzgl. € 6,95 netto Fracht. Maßstab: ca. 1:1. Stand 05/24.





| | | | | | |
|--|---|----------|---|--|--|
| | R 1489 | R 1489-A | R 1330 sw | | |
| |  | k. A. |  | | |





| | | | | | |
|---|--|---|--|--|--|
| R 951 | | R 1290 | | | |
|  | |  | | | |





| | | | | | |
|---|--|--|--|--|--|
| R 8738 | | | | | |
|  | | | | | |





| | | | | |
|---|--|---|--|---|
| R 2313 gr | | R 8719 sw | | R 5829 sw |
|  | |  | |  |

Genauere Angaben zu den Farben, Werkstoffen und Abnahmemengen siehe bitte Preisliste. Konstruktionsänderungen an den Querschnitten vorbehalten - Zur Abklärung der Passgenauigkeit bitte vor Bestellung ein 10cm-Muster anfordern. Lieferung ab Warenwert € 40,- netto frei Haus, ansonsten zzgl. € 6,95 netto Fracht. Maßstab: ca. 1:1. Stand 07/23.







| | | | | | |
|--|---|---|---|---|--|
| | R 9575 | R 806 sw | R 1587 sw | R 1161 sw | |
| |  |  |  |  | |







| | | | | | |
|--|--|---|---|---|---|
| R 552 sw | | R 1144 | R 592 gr | R 1951 gr | R 1470 sw |
|  | |  |  |  |  |







| | | | | | |
|---|---|--|---|--|---|
| R 2095 | R 2059 | | R 549 sw | | R 2104 sw |
|  |  | |  | |  |





| | | | |
|---|---|---|---|
| R 1581 | R 1900 | Z 7522 sw | R 1782 sw |
|  |  |  |  |

Genauere Angaben zu den Farben, Werkstoffen und Abnahmemengen siehe bitte Preisliste. Konstruktionsänderungen an den Querschnitten vorbehalten - Zur Abklärung der Passgenauigkeit bitte vor Bestellung ein 10cm-Muster anfordern. Lieferung ab Warenwert € 40,- netto frei Haus, ansonsten zzgl. € 6,95 netto Fracht. Maßstab: ca. 1:1. Stand 06/23.





| | | | | | |
|---|---|---|---|---|---|
| R 2096 | R 2526 gr | R 8617 sw | R 8767 | R 644 | R 716 gr |
|  |  |  |  |  |  |

| | | | | | |
|---|---|---|---|---|---|
| R 821 sw | R 2359 sw | R 1874 | R 8513 sw | R 8866 sw | R 9595 sw |
|  |  |  |  |  |  |

| | | | | | |
|---|---|---|---|---|---|
| R 832 w | R 1766 | R 885 sw | R 1770 | R 8531 sw | R 1778 sw |
|  |  |  |  |  |  |

| | | | | | |
|--|---|---|---|--|---|
| | R 2517 gr | R 560 sw | R 1753 sw | | R 1309 |
| |  |  |  | |  |



Genauere Angaben zu den Farben, Werkstoffen und Abnahmemengen siehe bitte Preisliste. Konstruktionsänderungen an den Querschnitten vorbehalten - Zur Abklärung der Passgenauigkeit bitte vor Bestellung ein 10cm-Muster anfordern. Lieferung ab Warenwert € 40,- netto frei Haus, ansonsten zzgl. € 6,95 netto Fracht. Maßstab: ca. 1:1. Stand 07/23.

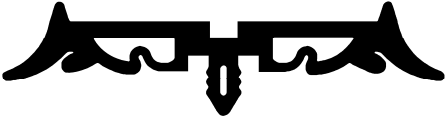

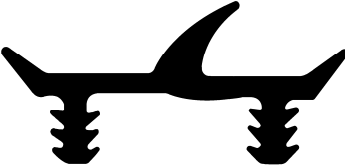

| | | | |
|---|---|--|---|
| R 8903 | R 5769 gr | R 9508 sw | R 8664 |
|  |  |  |  |



| | |
|---|--|
| R 5836 sw | R 5572 |
|  |  |





| | |
|---|--|
| R 5565 sw | R 9579 sw |
|  |  |

Genauere Angaben zu den Farben, Werkstoffen und Abnahmemengen siehe bitte Preisliste. Konstruktionsänderungen an den Querschnitten vorbehalten - Zur Abklärung der Passgenauigkeit bitte vor Bestellung ein 10cm-Muster anfordern. Lieferung ab Warenwert € 40,- netto frei Haus, ansonsten zzgl. € 6,95 netto Fracht. Maßstab: ca. 1:1. Stand 10/23.

| | | | | | |
|---|--|---|---|--|--|
| R 8933 | | R 1397 | R 627 sw | | |
|  | |  |  | | |





| | | | | |
|--|---|---|---|---|
| R 1379 | R 1947 | R 824 | R 825 sw | R 2088 sw |
|  |  |  |  |  |







| | | | | |
|---|---|--|--|---|
| R 8609 sw | R 2518 | | | R 8736 |
|  |  | | |  |







| | | | | | |
|---|---|--|---|--|---|
| R 8546 sw | R 8751 sw | | R 9542 | | R 5753 gr |
|  |  | |  | |  |

Genauere Angaben zu den Farben, Werkstoffen und Abnahmemengen siehe bitte Preisliste. Konstruktionsänderungen an den Querschnitten vorbehalten - Zur Abklärung der Passgenauigkeit bitte vor Bestellung ein 10cm-Muster anfordern. Lieferung ab Warenwert € 40,- netto frei Haus, ansonsten zzgl. € 6,95 netto Fracht. Maßstab: ca. 1:1. Stand 01/23.



| | | | | | |
|--|---|--|--|--|--|
| | R 676 sw | | | | |
| |  nicht für Treppenstufen geeignet | | | | |





| | | | | | |
|---|--|---|---|---|--|
| R 1938 sw | | R 1828 sw | R 1828-B | R 2125 sw | |
|  | |  |  |  | |







| | | | | | |
|---|---|---|---|---|---|
| R 1914 sw | R 827 sw | R 8876 | R 1800 sw | R 800 sw | R 1519 sw |
|  |  |  |  |  |  |





| | | | | | |
|---|---|---|---|---|---|
| R 1127 | R 2127 sw | R 1848 | R 8939 sw | R 1370 | R 1001 br/sw |
|  |  |  |  |  |  |

Genauere Angaben zu den Farben, Werkstoffen und Abnahmemengen siehe bitte Preisliste. Konstruktionsänderungen an den Querschnitten vorbehalten - Zur Abklärung der Passgenauigkeit bitte vor Bestellung ein 10cm-Muster anfordern. Lieferung ab Warenwert € 40,- netto frei Haus, ansonsten zzgl. € 6,95 netto Fracht. Maßstab: ca. 1:1. Stand 06/24.



| | | | | |
|---|--|--|---|--|
| R 5842 SW | | | R 1242 SW | |
|  | | |  | |



| | | | | | |
|---|--|---|---|--|---|
| R 8970 SW | | R 8797 SW | R 1455 | | R 5837 SW |
|  | |  |  | |  |



| | | | | | |
|---|---|---|---|---|---|
| R 1244 SW | R 601 SW | R 5649 | R 2007 SW | R 1100 SW | R 964 |
|  |  |  |  |  |  |



| | | | | | |
|---|---|---|--|---|---|
| R 946 | R 1000 | R 8966 | | R 881 SW | R 1348 |
|  |  |  | |  |  |

Genauere Angaben zu den Farben, Werkstoffen und Abnahmemengen siehe bitte Preisliste. Konstruktionsänderungen an den Querschnitten vorbehalten - Zur Abklärung der Passgenauigkeit bitte vor Bestellung ein 10cm-Muster anfordern. Lieferung ab Warenwert € 40,- netto frei Haus, ansonsten zzgl. € 6,95 netto Fracht. Maßstab: ca. 1:1. Stand 10/23.

| | | | | | |
|---|---|--|---|--|--|
| R 1394 | R 5632 sw | | R 1082 | | |
|  |  | |  | | |

| | | | | | |
|---|--|--|--|--|---|
| R 2109 | | | | | R 8616 |
|  | | | | |  |

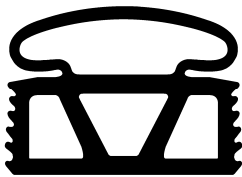
| | | |
|--|---|---|
| | R 2184 | R 1889 |
| |  |  |

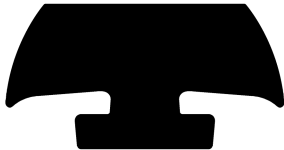
| | | |
|---|---|---|
| R 5687 | R 9568 | R 8837 |
|  |  |  |

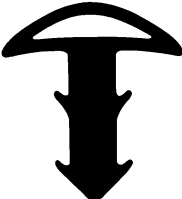
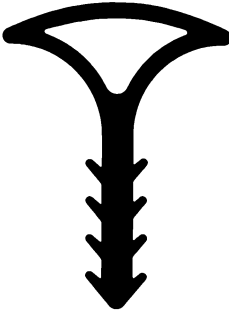
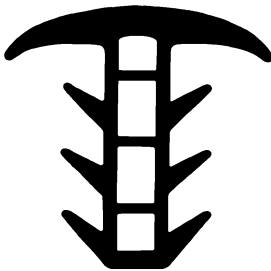

Genauere Angaben zu den Farben, Werkstoffen und Abnahmemengen siehe bitte Preisliste. Konstruktionsänderungen an den Querschnitten vorbehalten - Zur Abklärung der Passgenauigkeit bitte vor Bestellung ein 10cm-Muster anfordern. Lieferung ab Warenwert € 40,- netto frei Haus, ansonsten zzgl. € 6,95 netto Fracht. Maßstab: ca. 1:1. Stand 10/23.

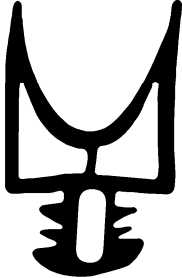

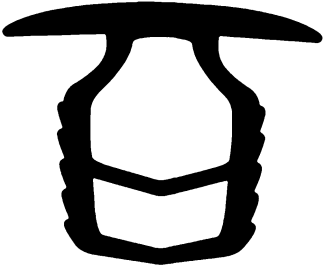
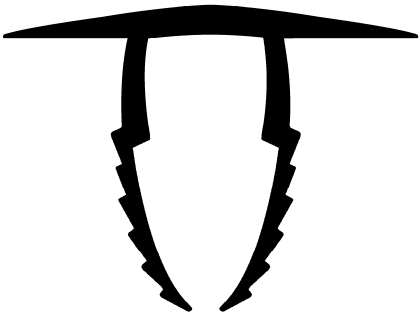
| | | | |
|---|---|--|---|
| R 1226 SW | R 956 | | R 1209 SW |
|  |  | |  |



| | | | |
|--|--|---|--|
| | | R 5756 | |
| | |  | |

| | |
|---|--|
| R 1106 SW | R 8873 |
|  |  |

Genauere Angaben zu den Farben, Werkstoffen und Abnahmemengen siehe bitte Preisliste. Konstruktionsänderungen an den Querschnitten vorbehalten - Zur Abklärung der Passgenauigkeit bitte vor Bestellung ein 10cm-Muster anfordern. Lieferung ab Warenwert € 40,- netto frei Haus, ansonsten zzgl. € 6,95 netto Fracht. Maßstab: ca. 1:1. Stand 09/20.



| | | |
|---|--|---|
| R 1076 | | R 1825 |
|  | |  |



| | |
|---|--|
| R 975 sw | R 1765 |
|  |  |

| | |
|---|--|
| R 5785 | R 5752 |
|  |  |

| | | |
|--|--|--|
| | | |
| | | |



Genauere Angaben zu den Farben, Werkstoffen und Abnahmemengen siehe bitte Preisliste. Konstruktionsänderungen an den Querschnitten vorbehalten - Zur Abklärung der Passgenauigkeit bitte vor Bestellung ein 10cm-Muster anfordern. Lieferung ab Warenwert € 40,- netto frei Haus, ansonsten zzgl. € 6,95 netto Fracht. Maßstab: ca. 1:1. Stand 10/21.

| | |
|---|--|
| R 9592 | R 9592-A sw |
|  |  |

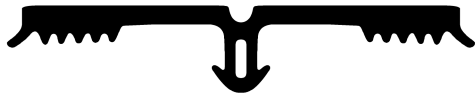
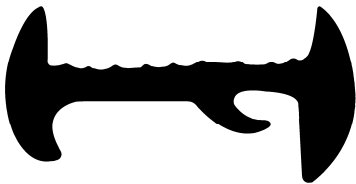
| | |
|---|--|
| R 5549 | R 5643 |
|  |  |

| | |
|---|--|
| R 5702 sw | R 5568 |
|  |  |







Genauere Angaben zu den Farben, Werkstoffen und Abnahmemengen siehe bitte Preisliste. Konstruktionsänderungen an den Querschnitten vorbehalten - Zur Abklärung der Passgenauigkeit bitte vor Bestellung ein 10cm-Muster anfordern. Lieferung ab Warenwert € 40,- netto frei Haus, ansonsten zzgl. € 6,95 netto Fracht. Maßstab: ca. 1:1. Stand 10/23.







| R 2117 sw | R 8832 sw |
|---|--|
|  <p>60mm</p> |  |







| R 2306 |
|--|
|  <p>80mm</p> |







| R 2133 |
|---|
|  <p>100mm</p> |

Genaue Angaben zu den Farben, Werkstoffen und Abnahmemengen siehe bitte Preisliste. Konstruktionsänderungen an den Querschnitten vorbehalten - Zur Abklärung der Passgenauigkeit bitte vor Bestellung ein 10cm-Muster anfordern. Lieferung ab Warenwert € 40,- netto frei Haus, ansonsten zzgl. € 6,95 netto Fracht. Maßstab: ca. 1:1. Stand 08/23.







| | | | | | |
|---|---|---|---|---|---|
| R 871 | R 543 gr/sw | R 538 sw/w | R 657 sw | R 581 sw | R 582 |
|  |  |  |  |  |  |







| | | | | | |
|---|---|---|---|---|---|
| R 1117 | R 1256 sw | R 1033 | R 8835 sw | R 1993 gr | R 1805 sw |
|  |  |  |  |  |  |







| | | | | | |
|---|---|---|---|---|---|
| R 655 | R 593 sw | R 670 sw | R 856 gr | R 1175 sw | R 569 sw |
|  |  |  |  |  |  |







| | | | | | |
|---|---|---|---|---|---|
| R 747 | R 748 sw | R 2301 sw | R 820 gr | R 1157 | R 1157-A sw |
|  |  |  |  |  |  |

Genauere Angaben zu den Farben, Werkstoffen und Abnahmemengen siehe bitte Preisliste. Konstruktionsänderungen an den Querschnitten vorbehalten - Zur Abklärung der Passgenauigkeit bitte vor Bestellung ein 10cm-Muster anfordern. Lieferung ab Warenwert € 40,- netto frei Haus, ansonsten zzgl. € 6,95 netto Fracht. Maßstab: ca. 1:1. Stand 06/23.





| | | | | | |
|---|---|---|---|---|---|
| R 2039 SW | R 1474 SW | R 5810 SW | R 746 | R 618 W | R 546 SW |
|  |  |  |  |  |  |







| | | | | | |
|---|---|---|---|---|---|
| R 1918 | R 2006 | R 2375 SW | R 8652 | R 1598 SW | R 555 SW |
|  |  |  |  |  |  |



| | | | | | |
|---|---|---|---|---|---|
| R 649 SW | R 1989 SW | R 8804 SW | R 656 gr | R 8638 | R 1870 SW |
|  |  |  |  |  |  |





| | | | | | |
|---|---|---|---|---|---|
| R 2032 | R 1162 SW | R 509 | R 8892 | R 793 | R 8534 SW |
|  |  |  |  |  |  |

Genauere Angaben zu den Farben, Werkstoffen und Abnahmemengen siehe bitte Preisliste. Konstruktionsänderungen an den Querschnitten vorbehalten - Zur Abklärung der Passgenauigkeit bitte vor Bestellung ein 10cm-Muster anfordern. Lieferung ab Warenwert € 40,- netto frei Haus, ansonsten zzgl. € 6,95 netto Fracht. Maßstab: ca. 1:1. Stand 01/24.







| | | | | | |
|---|---|--|---|---|---|
| R 743 | R 836 sw | | R 8717 | R 8706 | R 1546 |
|  |  | |  |  |  |







| | | | | | |
|---|---|---|---|---|---|
| R 1024 | R 652 sw | R 936 | R 1893 gr | R 2110 | R 8981 |
|  |  |  |  |  |  |





| | | | | | |
|---|---|---|---|---|---|
| R 619 gr | R 620 | R 898 sw | R 1742 sw | R 9550 sw | R 1019 |
|  |  |  |  |  |  |





| | | | | |
|---|---|---|--|---|
| R 1446 | R 5758 | R 517 | | R 589 gr |
|  |  |  | |  |

Genauere Angaben zu den Farben, Werkstoffen und Abnahmemengen siehe bitte Preisliste. Konstruktionsänderungen an den Querschnitten vorbehalten - Zur Abklärung der Passgenauigkeit bitte vor Bestellung ein 10cm-Muster anfordern. Lieferung ab Warenwert € 40,- netto frei Haus, ansonsten zzgl. € 6,95 netto Fracht. Maßstab: ca. 1:1. Stand 06/24.





| | | | | | |
|---|---|---|---|---|---|
| R 853 SW | R 645 SW | R 645-A SW | R 645-B SW | R 2008 SW | R 5518 SW |
|  |  |  |  |  |  |







| | | | | | |
|---|---|---|---|---|---|
| R 675 | R 2148 | R 2148-A SW | R 2368 SW | R 8993 SW | R 703 |
|  |  |  |  |  |  |





| | | | | | |
|---|---|---|---|--|---|
| R 805 | R 571 | R 5771 SW | R 2147 SW | | R 5501 |
|  |  |  |  | |  |







| | | | | |
|---|---|---|---|---|
| R 1360 SW | R 1306 SW | R 1119 SW | R 1119-A SW | R 8742 |
|  |  |  |  |  |

Genauere Angaben zu den Farben, Werkstoffen und Abnahmemengen siehe bitte Preisliste. Konstruktionsänderungen an den Querschnitten vorbehalten - Zur Abklärung der Passgenauigkeit bitte vor Bestellung ein 10cm-Muster anfordern. Lieferung ab Warenwert € 40,- netto frei Haus, ansonsten zzgl. € 6,95 netto Fracht. Maßstab: ca. 1:1. Stand 09/23.





| | | | | | |
|---|---|---|--|---|---|
| R 613 gr | R 2508 | R 1118 sw | | R 1934 sw | R 1887 sw |
|  |  |  | |  |  |



| | | | | | |
|---|---|---|---|---|---|
| R 876 sw | R 1113 sw | R 1305 | R 1795 sw | R 1419 sw | R 1251 |
|  |  |  |  |  |  |



| | | | | | |
|---|---|---|--|---|--|
| R 1236 | R 691 gr | R 1292 | | R 1844 | |
|  |  |  | |  | |

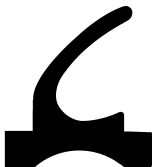

| | | | | | |
|---|---|---|---|---|---|
| R 833 | R 2086 | R 1408 sw | R 1408-A sw | R 1283 | R 8806 |
|  |  |  |  |  |  |

Genauere Angaben zu den Farben, Werkstoffen und Abnahmemengen siehe bitte Preisliste. Konstruktionsänderungen an den Querschnitten vorbehalten - Zur Abklärung der Passgenauigkeit bitte vor Bestellung ein 10cm-Muster anfordern. Lieferung ab Warenwert € 40,- netto frei Haus, ansonsten zzgl. € 6,95 netto Fracht. Maßstab: ca. 1:1. Stand 06/24.







| | | | | | |
|---|---|--|---|--|---|
| R 9515 | R 5696 | | R 9513 | | R 5645 |
|  |  | |  | |  |







| | | | | | |
|---|--|---|--|--|--|
| R 9535 sw | | R 5554 | | R 9564 | |
|  | |  | |  | |







| | | | | | |
|---|--|---|--|--|--|
| R 8954 gr/sw | | R 5531 | | | |
|  | |  | | | |





| | | | | | |
|--|---|--|--|--|---|
| | R 5663 | | | | R 8976 sw |
| |  | | | |  |

Genauere Angaben zu den Farben, Werkstoffen und Abnahmemengen siehe bitte Preisliste. Konstruktionsänderungen an den Querschnitten vorbehalten - Zur Abklärung der Passgenauigkeit bitte vor Bestellung ein 10cm-Muster anfordern. Lieferung ab Warenwert € 40,- netto frei Haus, ansonsten zzgl. € 6,95 netto Fracht. Maßstab: ca. 1:1. Stand 06/24.

| | | | | | |
|---|---|---|---|---|---|
| R 1566 | R 1547 | R 1593 | R 704 | R 887 gr | R 668 |
|  |  |  |  |  |  |

| | | | | | |
|---|---|---|---|---|---|
| R 2089 sw | R 5826 sw | R 788 | R 721 | R 647 | R 521 |
|  |  |  |  |  |  |

| | | | | | |
|---|---|---|---|---|---|
| R 8967 | R 1158 | R 1122 | R 1353 | R 594 sw | R 1331 |
|  |  |  |  |  |  |

| | | | | | |
|---|---|---|--|--|---|
| R 623 | R 654 | R 1020 sw | | | R 750 |
|  |  |  | | |  |



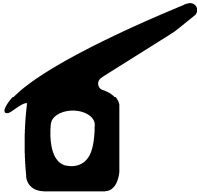



Genauere Angaben zu den Farben, Werkstoffen und Abnahmemengen siehe bitte Preisliste. Konstruktionsänderungen an den Querschnitten vorbehalten - Zur Abklärung der Passgenauigkeit bitte vor Bestellung ein 10cm-Muster anfordern. Lieferung ab Warenwert € 40,- netto frei Haus, ansonsten zzgl. € 6,95 netto Fracht. Maßstab: ca. 1:1. Stand 06/24.







| | |
|---|--|
| R 8822 | |
|  | |







| | |
|---|---|
| R 8928 | R 8894 |
|  |  |





| | |
|--|--|
| | |
| | |

Genauere Angaben zu den Farben, Werkstoffen und Abnahmemengen siehe bitte Preisliste. Konstruktionsänderungen an den Querschnitten vorbehalten - Zur Abklärung der Passgenauigkeit bitte vor Bestellung ein 10cm-Muster anfordern. Lieferung ab Warenwert € 40,- netto frei Haus, ansonsten zzgl. € 6,95 netto Fracht. Maßstab: ca. 1:1. Stand 01/23.





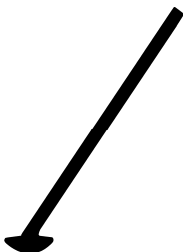

| | | | | | |
|---|---|---|---|---|---|
| R 688 SW | R 1743 SW | R 708 SW | R 683 | R 1267 | R 1278 |
|  |  |  |  |  |  |



| | | | | | |
|---|---|---|---|---|---|
| R 1411 | R 1237 | R 1596 SW | R 8823 | R 2349 | R 1278-A SW |
|  |  |  |  |  |  |





| | | | | | |
|---|---|---|---|---|---|
| R 8633 | R 1915 | R 1457 | R 1410 | R 529 | R 1057 |
|  |  |  |  |  |  |





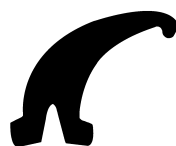

| | | | | |
|---|---|---|---|---|
| R 1497 SW | R 1497-B | R 519 SW | R 1277 SW | R 8758 |
|  |  |  |  |  |

Genauere Angaben zu den Farben, Werkstoffen und Abnahmemengen siehe bitte Preisliste. Konstruktionsänderungen an den Querschnitten vorbehalten - Zur Abklärung der Passgenauigkeit bitte vor Bestellung ein 10cm-Muster anfordern. Lieferung ab Warenwert € 40,- netto frei Haus, ansonsten zzgl. € 6,95 netto Fracht. Maßstab: ca. 1:1. Stand 08/23.





| | | | | | |
|---|---|---|---|---|---|
| R 807 gr | R 612 gr | R 792 sw | R 8890 | R 8891 | R 5530 |
|  |  |  |  |  |  |







| | | | | | |
|---|---|--|--|---|---|
| R 622 sw | R 1873 | | | R 8619 sw | R 822 sw |
|  |  | | |  |  |







| | | | | | |
|---|---|--|---|---|---|
| R 835 | R 1483 | | R 8691 | R 9594 sw | R 1368 |
|  |  | |  |  |  |







| | | | | | |
|---|---|---|---|---|---|
| R 1451 | R 559 | R 1447 | R 8957 | R 8900 | R 2105 |
|  |  |  |  |  |  |

Genauere Angaben zu den Farben, Werkstoffen und Abnahmemengen siehe bitte Preisliste. Konstruktionsänderungen an den Querschnitten vorbehalten - Zur Abklärung der Passgenauigkeit bitte vor Bestellung ein 10cm-Muster anfordern. Lieferung ab Warenwert € 40,- netto frei Haus, ansonsten zzgl. € 6,95 netto Fracht. Maßstab: ca. 1:1. Stand 07/23.



| | | | | | |
|---|---|---|---|--|---|
| R 1298 sw | R 1861 | R 1495 | R 843 gr | | R 5801 sw |
|  |  |  |  | |  |







| | | | | | |
|---|---|---|---|---|---|
| R 1995 | R 2052 | R 8759 | R 535 | R 9587 | R 1404 |
|  |  |  |  |  |  |







| | | | | | |
|---|---|---|---|---|---|
| R 1168 | R 1116 sw | R 663 sw | R 723 sw | R 1114 | R 1172 sw |
|  |  |  |  |  |  |







| | | | | | |
|---|---|---|---|---|---|
| R 1832 sw | R 1832-A sw | R 616 sw | R 2338 sw | R 1023 sw | R 1268 sw |
|  |  |  |  |  |  |

Genauere Angaben zu den Farben, Werkstoffen und Abnahmemengen siehe bitte Preisliste. Konstruktionsänderungen an den Querschnitten vorbehalten - Zur Abklärung der Passgenauigkeit bitte vor Bestellung ein 10cm-Muster anfordern. Lieferung ab Warenwert € 40,- netto frei Haus, ansonsten zzgl. € 6,95 netto Fracht. Maßstab: ca. 1:1. Stand 11/23.







| | | | | | |
|--|---|--|--|--|---|
| | R 5704 | | | | R 1192 |
| |  | | | |  |







| | | | | | |
|---|---|---|---|---|---|
| R 1148 sw | R 523 tr | R 987 | R 959 tr | R 1154 sw | R 8968 |
|  |  |  |  |  |  |





| | | | | | |
|---|---|---|---|---|---|
| R 976 | R 1071 sw | R 963 | R 2523 | R 1475 | R 1264 |
|  |  |  |  |  |  |







| | | | | | |
|---|---|---|---|---|---|
| R 2389 | R 1015 | R 1819 sw | R 1911 | R 1248 | R 2022 |
|  |  |  |  |  |  |

Genauere Angaben zu den Farben, Werkstoffen und Abnahmemengen siehe bitte Preisliste. Konstruktionsänderungen an den Querschnitten vorbehalten - Zur Abklärung der Passgenauigkeit bitte vor Bestellung ein 10cm-Muster anfordern. Lieferung ab Warenwert € 40,- netto frei Haus, ansonsten zzgl. € 6,95 netto Fracht. Maßstab: ca. 1:1. Stand 11/23.



| | | | | | |
|---|---|---|---|---|---|
| R 1791 sw | R 899 | R 2053 | R 2023 | R 2021 | R 2183 |
|  |  |  |  |  |  |

| | | | | | |
|---|---|---|---|---|---|
| R 854 sw | R 1014 | R 8810 sw | R 2076 | R 2079 sw | R 896 |
|  |  |  |  |  |  |

| | | | | | |
|---|---|--|---|---|---|
| R 701 | R 702 tr | | R 1442 | R 1180 | R 1322 sw |
|  |  | |  |  |  |

| | | | | | |
|---|---|---|---|---|---|
| R 505 sw | R 705 sw | R 706 tr | R 707 | R 8673 | R 1967 |
|  |  |  |  |  |  |





Genauere Angaben zu den Farben, Werkstoffen und Abnahmemengen siehe bitte Preisliste. Konstruktionsänderungen an den Querschnitten vorbehalten - Zur Abklärung der Passgenauigkeit bitte vor Bestellung ein 10cm-Muster anfordern. Lieferung ab Warenwert € 40,- netto frei Haus, ansonsten zzgl. € 6,95 netto Fracht. Maßstab: ca. 1:1. Stand 06/24.

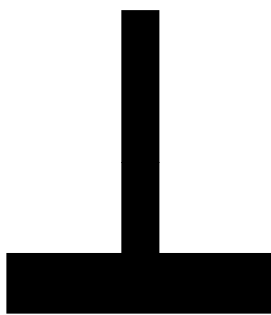
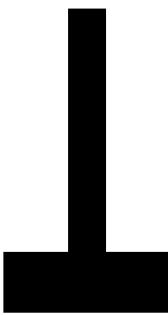



| | | | |
|---|--|---|--|
| R 8515 | | R 2069 | |
|  | |  | |







| | | | |
|--|--|--|---|
| | | | R 8533 |
| | | |  |







| | | | |
|---|---|--|--|
| R 9589 | R 9590 | | |
|  |  | | |

Genauere Angaben zu den Farben, Werkstoffen und Abnahmemengen siehe bitte Preisliste. Konstruktionsänderungen an den Querschnitten vorbehalten - Zur Abklärung der Passgenauigkeit bitte vor Bestellung ein 10cm-Muster anfordern. Lieferung ab Warenwert € 40,- netto frei Haus, ansonsten zzgl. € 6,95 netto Fracht. Maßstab: ca. 1:1. Stand 01/24.





| | | | | | |
|--|---|---|---|---|---|
| | R 1039 sw | R 1011 | R 1021 | R 849 | R 1067 |
| |  |  |  |  |  |





| | | | | | |
|---|---|---|---|--|---|
| R 1036 | R 1036-A | R 1036-B | R 1160 | | R 1773 |
|  |  |  |  | |  |





| | | | | | |
|---|---|---|---|---|---|
| R 803 sw | R 1049 sw | R 672 sw | R 672-A sw | R 648 sw | R 648-A sw |
|  |  |  |  |  |  |





| | | | | | |
|---|---|---|---|---|---|
| R 804 sw | R 818 sw | R 542 | R 1943 sw | R 1285 | R 8773 |
|  |  |  |  |  |  |

Genauere Angaben zu den Farben, Werkstoffen und Abnahmemengen siehe bitte Preisliste. Konstruktionsänderungen an den Querschnitten vorbehalten - Zur Abklärung der Passgenauigkeit bitte vor Bestellung ein 10cm-Muster anfordern. Lieferung ab Warenwert € 40,- netto frei Haus, ansonsten zzgl. € 6,95 netto Fracht. Maßstab: ca. 1:1. Stand 06/24.







| | | | | | |
|---|---|---|---|--|---|
| R 614 | R 1208 | R 1479 | R 1478 | | R 815 |
|  |  |  |  | |  |







| | | | | | |
|--|---|---|---|---|---|
| | R 626 sw | R 2098 | R 8841 sw | R 1074 | R 8768 |
| |  |  |  |  |  |





| | | | | | |
|---|---|--|--|---|---|
| R 526 tr | R 826 | | | R 740 | R 8650 |
|  |  | | |  |  |







| | | | | | |
|---|--|---|---|---|---|
| R 9541 sw | | R 5710 | R 8709 sw | R 553 gr | R 617 |
|  | |  |  |  |  |

Genauere Angaben zu den Farben, Werkstoffen und Abnahmemengen siehe bitte Preisliste. Konstruktionsänderungen an den Querschnitten vorbehalten - Zur Abklärung der Passgenauigkeit bitte vor Bestellung ein 10cm-Muster anfordern. Lieferung ab Warenwert € 40,- netto frei Haus, ansonsten zzgl. € 6,95 netto Fracht. Maßstab: ca. 1:1. Stand 05/24.







| | | | | | |
|---|---|---|---|---|---|
| R 2077 gr | R 2077-A | R 628 tr | R 605 sw | R 1170 | R 570 sw |
|  |  |  |  |  |  |



| | | | | | |
|---|---|---|---|---|---|
| R 1081 | R 1401 | R 1018 | R 733 sw | R 851 sw | R 2140 |
|  |  |  |  |  |  |



| | | | | | |
|---|---|---|--|---|---|
| R 2118 sw | R 8743 sw | R 873 sw | | R 8959 sw | R 8682 sw |
|  |  |  | |  |  |



| | | | | | |
|---|---|---|---|---|---|
| R 1754 sw | R 1838 | R 2025 | R 1590 gr | R 1849 | R 1774 |
|  |  |  |  |  |  |

Genauere Angaben zu den Farben, Werkstoffen und Abnahmemengen siehe bitte Preisliste. Konstruktionsänderungen an den Querschnitten vorbehalten - Zur Abklärung der Passgenauigkeit bitte vor Bestellung ein 10cm-Muster anfordern. Lieferung ab Warenwert € 40,- netto frei Haus, ansonsten zzgl. € 6,95 netto Fracht. Maßstab: ca. 1:1. Stand 08/23.







| | | | | | |
|---|---|---|---|---|---|
| R 8756 sw | R 1847 sw | R 693 gr | R 895 sw | R 8780 sw | R 8889 gr |
|  |  |  |  |  |  |







| | | | | | |
|---|---|--|--|---|--|
| R 1781 | R 8794 | | | R 9528 sw | |
|  |  | | |  | |







| | | | | | |
|--|---|--|---|--|--|
| | R 2528 sw | | R 5720 | | |
| |  | |  | | |







| | | | | | |
|--|--|---|--|--|---|
| | | R 9580 | | | R 3083 sw |
| | |  | | |  |

Genauere Angaben zu den Farben, Werkstoffen und Abnahmemengen siehe bitte Preisliste. Konstruktionsänderungen an den Querschnitten vorbehalten - Zur Abklärung der Passgenauigkeit bitte vor Bestellung ein 10cm-Muster anfordern. Lieferung ab Warenwert € 40,- netto frei Haus, ansonsten zzgl. € 6,95 netto Fracht. Maßstab: ca. 1:1. Stand 06/24.







| | | | | | |
|---|---|---|---|---|---|
| R 1726 sw | R 1153 sw | R 8749 sw | R 610 sw | R 1707 sw | R 8755 sw |
|  |  |  |  |  |  |







| | | | | | |
|---|---|---|---|---|---|
| R 879 sw | R 5774 sw | R 1710 gr/sw | R 1317 sw | R 1903 sw | R 2460 sw |
|  |  |  |  |  |  |







| | | | | | |
|---|---|---|---|---|---|
| R 8883 sw | R 1594 sw | R 1728 sw | R 1727 gr/sw | R 1727-A gr/sw | R 8811 sw |
|  |  |  |  |  |  |







| | | | | | |
|---|---|---|---|---|---|
| R 1304 sw | R 8869 | R 860 sw | R 1744 sw | R 730 gr/sw | R 1736 sw |
|  |  |  |  |  |  |

Genauere Angaben zu den Farben, Werkstoffen und Abnahmemengen siehe bitte Preisliste. Konstruktionsänderungen an den Querschnitten vorbehalten - Zur Abklärung der Passgenauigkeit bitte vor Bestellung ein 10cm-Muster anfordern. Lieferung ab Warenwert € 40,- netto frei Haus, ansonsten zzgl. € 6,95 netto Fracht. Maßstab: ca. 1:1. Stand 01/23.







| | | | | | |
|---|---|---|---|---|---|
| R 852 sw | R 1783 sw | R 1731 sw | R 1729 sw | R 1732 sw | R 2167 sw |
|  |  |  |  |  |  |







| | | | | | |
|---|---|---|---|---|---|
| R 1588 sw | R 2527 sw | R 8798 | R 1738 sw | R 1741 | R 8523 sw |
|  |  |  |  |  |  |





| | | | | | |
|---|---|---|---|---|---|
| R 1156 sw | R 1261 sw | R 557 gr/sw | R 1259 sw | R 1259-A sw | R 8613 sw |
|  |  |  |  |  |  |





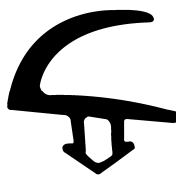

| | | | | | |
|---|---|---|---|---|---|
| R 1864 sw | R 1321 sw | R 1321-A sw | R 869 gr | R 520 sw | R 689 sw |
|  |  |  |  |  |  |

Genauere Angaben zu den Farben, Werkstoffen und Abnahmemengen siehe bitte Preisliste. Konstruktionsänderungen an den Querschnitten vorbehalten - Zur Abklärung der Passgenauigkeit bitte vor Bestellung ein 10cm-Muster anfordern. Lieferung ab Warenwert € 40,- netto frei Haus, ansonsten zzgl. € 6,95 netto Fracht. Maßstab: ca. 1:1. Stand 02/23.

| | | | | | |
|---|---|---|---|---|---|
| R 8842 SW | R 2515 SW | R 8893 SW | R 5601 SW | R 8904 SW | R 2436 SW |
|  |  |  |  |  |  |

| | | | | | |
|---|---|---|---|---|---|
| R 5522 gr/sw | R 8897 SW | R 5648 SW | R 8948 SW | R 8918 SW | R 8919 SW |
|  |  |  |  |  |  |

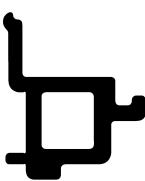
| | | | | | |
|---|---|---|---|---|---|
| R 5803 SW | R 2964 SW | R 8952 SW | R 5546 | R 8969 SW | R 9559 |
|  |  |  |  |  |  |

| | | | | | |
|---|---|---|---|---|---|
| R 8824 SW | R 8953 | R 5715 | R 5555 SW | R 5595 | R 8944 |
|  |  |  |  |  |  |



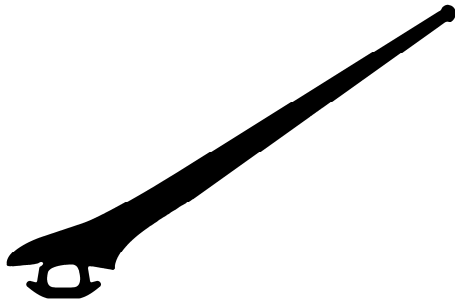

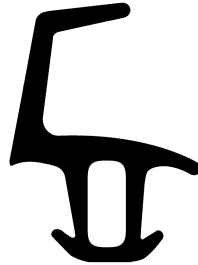
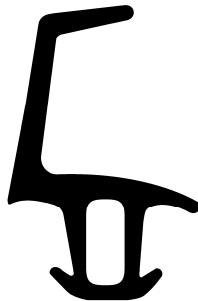

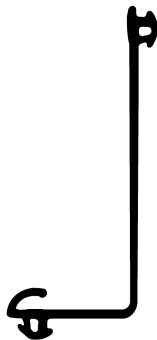
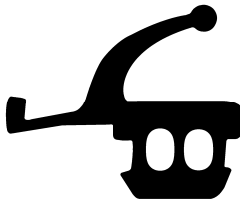
Genauere Angaben zu den Farben, Werkstoffen und Abnahmemengen siehe bitte Preisliste. Konstruktionsänderungen an den Querschnitten vorbehalten - Zur Abklärung der Passgenauigkeit bitte vor Bestellung ein 10cm-Muster anfordern. Lieferung ab Warenwert € 40,- netto frei Haus, ansonsten zzgl. € 6,95 netto Fracht. Maßstab: ca. 1:1. Stand 06/24.







| | | |
|---|--|--|
| R 8911 SW | | |
|  | | |







| | | | |
|--|--|---|--|
| | | R 5560 | R 5563 |
| | |  |  |







| | | | |
|---|--|--|---|
| R 5661 | | | R 8964 SW |
|  | | |  |

Genauere Angaben zu den Farben, Werkstoffen und Abnahmemengen siehe bitte Preisliste. Konstruktionsänderungen an den Querschnitten vorbehalten - Zur Abklärung der Passgenauigkeit bitte vor Bestellung ein 10cm-Muster anfordern. Lieferung ab Warenwert € 40,- netto frei Haus, ansonsten zzgl. € 6,95 netto Fracht. Maßstab: ca. 1:1. Stand 10/23.







| | | | | | |
|---|---|---|---|---|---|
| R 1708 SW | R 1724 SW | R 1724-A SW | R 1735 SW | R 1985 SW | R 8661 |
|  |  |  |  |  |  |







| | | | | | |
|---|---|---|---|---|---|
| R 1389 SW | R 2333 SW | R 842 SW | R 1383 SW | R 8620 SW | R 1186 SW |
|  |  |  |  |  |  |







| | | | | | |
|---|---|---|---|---|---|
| R 8639 SW | R 8651 SW | R 8752 SW | R 8707 gr | R 8747 SW | R 8733 gr/sw |
|  |  |  |  |  |  |





| | | | | | |
|---|---|---|---|---|---|
| R 1589 SW | R 8606 SW | R 2043 | R 1073 | R 2395 | R 8796 SW |
|  |  |  |  |  |  |

Genauere Angaben zu den Farben, Werkstoffen und Abnahmemengen siehe bitte Preisliste. Konstruktionsänderungen an den Querschnitten vorbehalten - Zur Abklärung der Passgenauigkeit bitte vor Bestellung ein 10cm-Muster anfordern. Lieferung ab Warenwert € 40,- netto frei Haus, ansonsten zzgl. € 6,95 netto Fracht. Maßstab: ca. 1:1. Stand 06/24.

| | | | | | |
|---|---|---|---|---|---|
| R 1768 SW | R 1299 SW | R 1739 SW | R 1725 SW | R 1711 SW | R 1246 SW |
|  |  |  |  |  |  |

| | | | | | |
|---|---|---|---|---|--|
| R 5699 SW | R 1423 SW | R 1751 gr/sw | R 2545 SW | R 8766 | R 9520 SW |
|  |  |  |  |  |  |

| | | | | | |
|---|---|---|---|---|---|
| R 8799 | R 8870 SW | R 5802 SW | R 8871 SW | R 8912 SW | R 8868 |
|  |  |  |  |  |  |

| | | | | | |
|---|---|--|---|---|---|
| R 9504 SW | R 3247 SW | | R 8995 SW | R 5832 SW | R 8940 SW |
|  |  | |  |  |  |

Genauere Angaben zu den Farben, Werkstoffen und Abnahmemengen siehe bitte Preisliste. Konstruktionsänderungen an den Querschnitten vorbehalten - Zur Abklärung der Passgenauigkeit bitte vor Bestellung ein 10cm-Muster anfordern. Lieferung ab Warenwert € 40,- netto frei Haus, ansonsten zzgl. € 6,95 netto Fracht. Maßstab: ca. 1:1. Stand 06/24.







| | | | | | |
|--|--|--|--|--|--|
| | | | | | |
| | | | | | |







| | | | | | |
|--|--|--|--|--|--|
| | | | | | |
| | | | | | |





| | | | | | |
|--|--|--|--|--|--|
| | | | | | |
| | | | | | |







| | | | | |
|--|--|---|--|--|
| | | R 5570 | | |
| | |  | | |

Genauere Angaben zu den Farben, Werkstoffen und Abnahmemengen siehe bitte Preisliste. Konstruktionsänderungen an den Querschnitten vorbehalten - Zur Abklärung der Passgenauigkeit bitte vor Bestellung ein 10cm-Muster anfordern. Lieferung ab Warenwert € 40,- netto frei Haus, ansonsten zzgl. € 6,95 netto Fracht. Maßstab: ca. 1:1. Stand 06/24.







| | | | | | |
|---|---|---|---|---|---|
| R 1265 sw | R 1206 sw | R 2525 sw | R 1702 sw | R 2571 sw | R 8725 sw |
|  |  |  |  |  |  |







| | | | | | |
|---|---|---|---|---|---|
| R 2547 sw | R 2546 gr/sw | R 1705 gr/sw | R 8763 sw | R 2548 sw | R 2549 sw |
|  |  |  |  |  |  |



| | | | | | |
|---|---|---|--|---|---|
| R 2066 sw | R 1747 sw | R 5792 sw | | R 1734 gr/sw | R 1733 sw |
|  |  |  | |  |  |





| | | | | | |
|---|---|---|---|---|---|
| R 1752 gr/sw | R 2503 sw | R 1302 sw | R 8914 sw | R 3243 sw | R 8999 sw |
|  |  |  |  |  |  |

Genauere Angaben zu den Farben, Werkstoffen und Abnahmemengen siehe bitte Preisliste. Konstruktionsänderungen an den Querschnitten vorbehalten - Zur Abklärung der Passgenauigkeit bitte vor Bestellung ein 10cm-Muster anfordern. Lieferung ab Warenwert € 40,- netto frei Haus, ansonsten zzgl. € 6,95 netto Fracht. Maßstab: ca. 1:1. Stand 06/24.







| | | | | | |
|---|---|---|---|---|---|
| R 8984 gr/sw | R 1746 lichtgrau/sw | R 5602 sw | R 8765 lichtgrau/sw | R 8765-A lichtgrau/sw | R 8765-B lichtgrau/sw |
|  |  |  |  |  |  |







| | | | | | |
|---|---|---|---|---|---|
| R 5647 sw | R 5835 lichtgrau/sw | R 9546 sw | R 9521 sw | R 5846 sw | R 9511 sw |
|  |  |  |  |  |  |





| | | | | | |
|--|---|---|--|--|---|
| | R 4510 sw | R 5604 sw | | | R 5631 sw |
| |  |  | | |  |







| | | | | | |
|---|---|---|---|--|---|
| R 5732 lgr/sw | R 5655 sw | R 5833 sw | R 5793 lichtgrau | | R 8974 lichtgrau |
|  |  |  |  | |  |

Genauere Angaben zu den Farben, Werkstoffen und Abnahmemengen siehe bitte Preisliste. Konstruktionsänderungen an den Querschnitten vorbehalten - Zur Abklärung der Passgenauigkeit bitte vor Bestellung ein 10cm-Muster anfordern. Lieferung ab Warenwert € 40,- netto frei Haus, ansonsten zzgl. € 6,95 netto Fracht. Maßstab: ca. 1:1. Stand 06/24.





| | | | | | |
|---|---|---|---|---|---|
| R 1125 SW | R 1387 SW | R 9525 | R 2081 SW | R 5705 | R 8787 |
|  |  |  |  |  |  |





| | | | | | |
|---|---|---|---|---|---|
| R 719 | R 718 | R 5697 | R 858 | R 858-A | R 1257 |
|  |  |  |  |  |  |





| | | | | | |
|---|---|---|---|--|---|
| R 8622 | R 8679 | R 8654 | R 5733 SW | | R 8683 SW |
|  |  |  |  | |  |



| | | | | | |
|---|---|---|---|---|---|
| R 8864 SW | R 1757 SW | R 799 SW | R 1328 SW | R 8777 SW | R 8712 SW |
|  |  |  |  |  |  |

Genauere Angaben zu den Farben, Werkstoffen und Abnahmemengen siehe bitte Preisliste. Konstruktionsänderungen an den Querschnitten vorbehalten - Zur Abklärung der Passgenauigkeit bitte vor Bestellung ein 10cm-Muster anfordern. Lieferung ab Warenwert € 40,- netto frei Haus, ansonsten zzgl. € 6,95 netto Fracht. Maßstab: ca. 1:1. Stand 06/24.





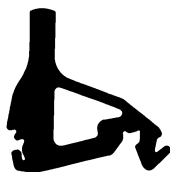

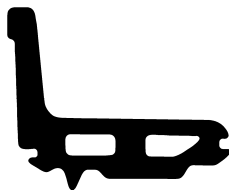
| | | | | | |
|---|---|---|---|--|---|
| R 1376 SW | R 717 SW | R 717-A SW | R 1809 SW | | R 8648 SW |
|  |  |  |  | |  |







| | | | | | |
|--|--|--|--|--|--|
| R 698 | | R 1200 | R 1200-A SW | R 1064 | R 9563 SW |
|  | |  |  |  |  |







| | | | | | |
|---|---|---|---|---|--|
| R 2024 | R 2024-A SW | R 8902 | R 1982 | R 967 | |
|  |  |  |  |  | |







| | | | |
|---|---|---|---|
| R 1134 | R 8840 | R 8815 | R 2765 SW |
|  |  |  |  |

Genauere Angaben zu den Farben, Werkstoffen und Abnahmemengen siehe bitte Preisliste. Konstruktionsänderungen an den Querschnitten vorbehalten - Zur Abklärung der Passgenauigkeit bitte vor Bestellung ein 10cm-Muster anfordern. Lieferung ab Warenwert € 40,- netto frei Haus, ansonsten zzgl. € 6,95 netto Fracht. Maßstab: ca. 1:1. Stand 01/23.







| | | | | | |
|---|---|---|---|---|---|
| R 1165 SW | R 1254 SW | R 2034 SW | R 801 | R 1381 SW | R 8529 SW |
|  |  |  |  |  |  |



| | | | | | |
|---|---|---|---|---|---|
| R 621 sw/w | R 2343 SW | R 2067 SW | R 514 SW | R 513 SW | R 891 SW |
|  |  |  |  |  |  |





| | | | | | |
|---|---|---|---|---|---|
| R 872 SW | R 1876 SW | R 1876-A SW | R 875 SW | R 2016 SW | R 8641 SW |
|  |  |  |  |  |  |



| | | | | | |
|---|---|---|---|---|---|
| R 9519 SW | R 2536 SW | R 680 | R 2356 SW | R 2056 SW | R 1467 |
|  |  |  |  |  |  |

Genauere Angaben zu den Farben, Werkstoffen und Abnahmemengen siehe bitte Preisliste. Konstruktionsänderungen an den Querschnitten vorbehalten - Zur Abklärung der Passgenauigkeit bitte vor Bestellung ein 10cm-Muster anfordern. Lieferung ab Warenwert € 40,- netto frei Haus, ansonsten zzgl. € 6,95 netto Fracht. Maßstab: ca. 1:1. Stand 06/24.







| | | | | | |
|---|---|---|---|---|---|
| R 8800 SW | R 8800-A SW | R 5640 SW | R 8826 SW | R 1909 | R 5681 SW |
|  |  |  |  |  |  |







| | | | | | |
|---|--|---|--|--|--|
| R 8857 | | R 5749 SW | | | |
|  | |  | | | |







| | | | | | |
|---|---|--|---|--|---|
| R 2794 SW | R 8962 SW | | R 9578 SW | | R 8846 SW |
|  |  | |  | |  |





| | | | | |
|---|--|---|--|---|
| R 5757 SW | | R 5513 SW | | R 5683 |
|  | |  | |  |

Genauere Angaben zu den Farben, Werkstoffen und Abnahmemengen siehe bitte Preisliste. Konstruktionsänderungen an den Querschnitten vorbehalten - Zur Abklärung der Passgenauigkeit bitte vor Bestellung ein 10cm-Muster anfordern. Lieferung ab Warenwert € 40,- netto frei Haus, ansonsten zzgl. € 6,95 netto Fracht. Maßstab: ca. 1:1. Stand 06/24.

| | | | | | |
|---|---|---|---|---|---|
| R 1135 | R 595 sw | R 2026 | R 1796 | R 8779 sw | R 1101 |
|  |  |  |  |  |  |

| | | | | | |
|---|---|---|---|---|---|
| R 1183 | R 823 | R 1210 sw | R 1155 sw | R 1788 sw | R 1280 sw |
|  |  |  |  |  |  |

| | | | | | |
|---|---|---|---|---|---|
| R 8724 sw | R 1807 sw | R 1807-A sw | R 8793 | R 8705 gr | R 8708 sw |
|  |  |  |  |  |  |





| | | | | | |
|---|---|--|---|---|---|
| R 751 sw | R 1954 sw | | R 850 | R 850-A | R 8601 |
|  |  | |  |  |  |

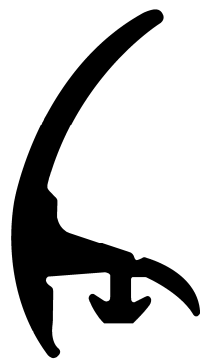





Genauere Angaben zu den Farben, Werkstoffen und Abnahmemengen siehe bitte Preisliste. Konstruktionsänderungen an den Querschnitten vorbehalten - Zur Abklärung der Passgenauigkeit bitte vor Bestellung ein 10cm-Muster anfordern. Lieferung ab Warenwert € 40,- netto frei Haus, ansonsten zzgl. € 6,95 netto Fracht. Maßstab: ca. 1:1. Stand 07/23.

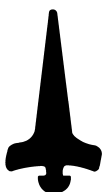





| | | | |
|---|--|--|--|
| R 2342 | | | |
|  | | | |







| | | | |
|--|--|--|--|
| | | R 5619 | |
| | |  | |

Genauere Angaben zu den Farben, Werkstoffen und Abnahmemengen siehe bitte Preisliste. Konstruktionsänderungen an den Querschnitten vorbehalten - Zur Abklärung der Passgenauigkeit bitte vor Bestellung ein 10cm-Muster anfordern. Lieferung ab Warenwert € 40,- netto frei Haus, ansonsten zzgl. € 6,95 netto Fracht. Maßstab: ca. 1:1. Stand 10/23.



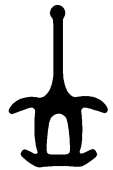

| | | | | | |
|---|---|---|---|---|---|
| R 687 sw | R 1045 sw | R 686 sw | R 1286 | R 8805 sw | R 8690 |
|  |  |  |  |  |  |



| | | | | | |
|---|--|---|---|---|---|
| R 1571 | R 611 | R 1329 | R 837 | R 845 | R 637 |
|  |  |  |  |  |  |



| | | | | | |
|---|---|---|---|---|---|
| R 1965 sw | R 1364 | R 556 | R 814 | R 8789 | R 580 sw |
|  |  |  |  |  |  |

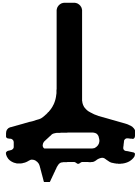

| | | | | | |
|---|---|---|---|---|---|
| R 1061 sw | R 2386 sw | R 1314 sw | R 1961 sw | R 1307 sw | R 2107 |
|  |  |  |  |  |  |

Genauere Angaben zu den Farben, Werkstoffen und Abnahmemengen siehe bitte Preisliste. Konstruktionsänderungen an den Querschnitten vorbehalten - Zur Abklärung der Passgenauigkeit bitte vor Bestellung ein 10cm-Muster anfordern. Lieferung ab Warenwert € 40,- netto frei Haus, ansonsten zzgl. € 6,95 netto Fracht. Maßstab: ca. 1:1. Stand 02/23.



| | | | | | |
|---|---|---|---|--|---|
| R 9512 | R 9529 | R 9586 SW | R 5772 SW | | R 9510 SW |
|  |  |  |  | |  |



| | | | | | |
|--|---|--|--|---|--|
| | R 5642 | | | R 5734 SW | |
| |  | | |  | |





| | | | | | |
|---|--|--|---|--|--|
| R 9596 | | | R 9581 | | |
|  | | |  | | |





| | | |
|--|---|---|
| | R 5614 | R 5542 |
| |  |  |

Genauere Angaben zu den Farben, Werkstoffen und Abnahmemengen siehe bitte Preisliste. Konstruktionsänderungen an den Querschnitten vorbehalten - Zur Abklärung der Passgenauigkeit bitte vor Bestellung ein 10cm-Muster anfordern. Lieferung ab Warenwert € 40,- netto frei Haus, ansonsten zzgl. € 6,95 netto Fracht. Maßstab: ca. 1:1. Stand 06/24.







| | | | | | |
|---|--|---|--|---|--|
| R 1450 | | R 1058 | | R 1462 | |
|  | |  | |  | |







| | | | | | |
|--|--|--|--|---|---|
| R 1439 | R 1414 sw | | | R 606 | R 1179 sw |
|  |  | | |  |  |







| | | | | | |
|---|---|--|---|---|---|
| R 8971 sw | R 8955 sw | | R 8838 sw | R 8838-A | R 8946 |
|  |  | |  |  |  |







| | | | | | |
|---|---|---|--|---|--|
| R 635 sw | R 1877 sw | R 2345 | | R 674 | |
|  |  |  | |  | |

Genauere Angaben zu den Farben, Werkstoffen und Abnahmemengen siehe bitte Preisliste. Konstruktionsänderungen an den Querschnitten vorbehalten - Zur Abklärung der Passgenauigkeit bitte vor Bestellung ein 10cm-Muster anfordern. Lieferung ab Warenwert € 40,- netto frei Haus, ansonsten zzgl. € 6,95 netto Fracht. Maßstab: ca. 1:1. Stand 02/23.







| | | | | | |
|---|---|---|---|---|---|
| R 1199 | R 2068 | R 8503 | R 2544 | R 742 | R 1418 sw |
|  |  |  |  |  |  |





| | | | | | |
|---|---|---|---|---|---|
| R 878 sw | R 2373 sw | R 8851 sw | R 8720 sw | R 1436 w | R 2080 |
|  |  |  |  |  |  |



| | | | | | |
|---|---|---|---|---|---|
| R 528 | R 596 | R 667 | R 1769 sw | R 8694 sw | R 8762 sw |
|  |  |  |  |  |  |

| | | | | | |
|---|---|---|---|---|---|
| R 727 sw | R 624 sw | R 574 tr | R 9593 | R 5557 | R 866 sw |
|  |  |  |  |  |  |

Genauere Angaben zu den Farben, Werkstoffen und Abnahmemengen siehe bitte Preisliste. Konstruktionsänderungen an den Querschnitten vorbehalten - Zur Abklärung der Passgenauigkeit bitte vor Bestellung ein 10cm-Muster anfordern. Lieferung ab Warenwert € 40,- netto frei Haus, ansonsten zzgl. € 6,95 netto Fracht. Maßstab: ca. 1:1. Stand 06/24.

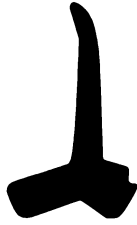
| | | | | | |
|---|---|---|---|---|---|
| R 1591 | R 1548 | R 1845 | R 700 | R 699 | R 1493 sw |
|  |  |  |  |  |  |

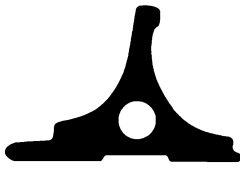
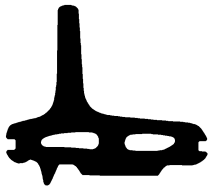
| | | | | | |
|--|--|--|--|--|--|
| R 8508 sw | R 8540 sw | R 1775 sw | R 8517 | R 2361 | R 2362 |
|  |  |  |  |  |  |

| | | |
|---|---|---|
| R 2355 | R 2143 | R 2144 |
|  |  |  |

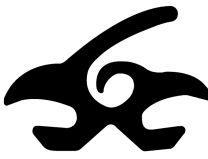
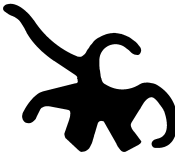



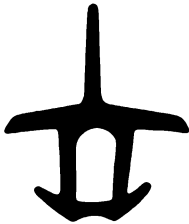
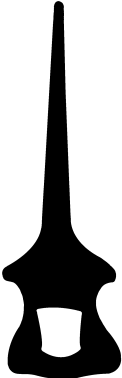

| | | |
|---|---|---|
| R 1568 sw | R 8924 | R 5571 |
|  |  |  |







Genauere Angaben zu den Farben, Werkstoffen und Abnahmemengen siehe bitte Preisliste. Konstruktionsänderungen an den Querschnitten vorbehalten - Zur Abklärung der Passgenauigkeit bitte vor Bestellung ein 10cm-Muster anfordern. Lieferung ab Warenwert € 40,- netto frei Haus, ansonsten zzgl. € 6,95 netto Fracht. Maßstab: ca. 1:1. Stand 10/23.







| | | | |
|---|--|--|--|
| R 8746 SW | | | |
|  | | | |







| | | | |
|---|--|--|---|
| R 1895 | | | R 5534 |
|  | | |  |

Genauere Angaben zu den Farben, Werkstoffen und Abnahmemengen siehe bitte Preisliste. Konstruktionsänderungen an den Querschnitten vorbehalten - Zur Abklärung der Passgenauigkeit bitte vor Bestellung ein 10cm-Muster anfordern. Lieferung ab Warenwert € 40,- netto frei Haus, ansonsten zzgl. € 6,95 netto Fracht. Maßstab: ca. 1:1. Stand 09/23.







| | | | | | |
|---|---|---|---|---|---|
| R 1149 sw | R 870 sw | R 633 | R 537 sw | R 696 gr | R 2522 |
|  |  |  |  |  |  |





| | | | | | |
|---|---|---|---|---|---|
| R 725 sw | R 868 sw | R 8629 sw | R 724 sw | R 8772 sw | R 8701 sw |
|  |  |  |  |  |  |







| | | | | | |
|---|---|---|---|---|---|
| R 629 w | R 711 w | R 1228 sw | R 855 sw | R 8642 sw | R 8776 sw |
|  |  |  |  |  |  |





| | | | | | |
|---|---|---|---|---|---|
| R 2364 | R 863 sw | R 1872 sw | R 1104 sw | R 1139 sw | R 1139-A |
|  |  |  |  |  |  |

Genauere Angaben zu den Farben, Werkstoffen und Abnahmemengen siehe bitte Preisliste. Konstruktionsänderungen an den Querschnitten vorbehalten - Zur Abklärung der Passgenauigkeit bitte vor Bestellung ein 10cm-Muster anfordern. Lieferung ab Warenwert € 40,- netto frei Haus, ansonsten zzgl. € 6,95 netto Fracht. Maßstab: ca. 1:1. Stand 06/24.





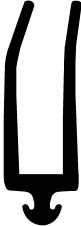

| | | | | | |
|---|---|---|---|---|---|
| R 536 | R 2506 gr | R 726 | R 2012 | R 829 sw | R 677 sw |
|  |  |  |  |  |  |





| | | | | |
|---|---|---|---|--|
| R 874 | R 1080 | R 1230 | R 897 sw | R 8526 |
|  |  |  |  |  |





| | | | | | |
|---|---|---|---|---|---|
| R 993 | R 882 | R 1978 sw | R 8744 | R 2057 | R 5739 sw |
|  |  |  |  |  |  |



| | | | | | |
|---|---|---|---|---|---|
| R 512 sw | R 2046 sw | R 650 sw | R 566 sw | R 1040 | R 8760 sw |
|  |  |  |  |  |  |

Genauere Angaben zu den Farben, Werkstoffen und Abnahmemengen siehe bitte Preisliste. Konstruktionsänderungen an den Querschnitten vorbehalten - Zur Abklärung der Passgenauigkeit bitte vor Bestellung ein 10cm-Muster anfordern. Lieferung ab Warenwert € 40,- netto frei Haus, ansonsten zzgl. € 6,95 netto Fracht. Maßstab: ca. 1:1. Stand 01/24.





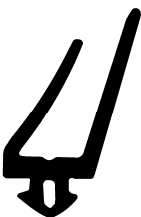

| | | | | | |
|---|---|---|---|---|---|
| R 2153 | R 5743 | R 9544 sw | R 5622 sw | R 8544 | R 5527 |
|  |  |  |  |  |  |







| | | | | |
|---|---|---|---|---|
| R 5794 sw | R 9574 gr | R 5742 | R 8932 sw | R 5783 sw |
|  |  |  |  |  |







| | | | |
|---|---|---|---|
| R 9555 sw | R 5698 | R 5623 sw | R 5615 |
|  |  |  |  |







| | | |
|---|---|--|
| R 5790 sw | R 5676 | R 8980 |
|  |  |  |

Genauere Angaben zu den Farben, Werkstoffen und Abnahmemengen siehe bitte Preisliste. Konstruktionsänderungen an den Querschnitten vorbehalten - Zur Abklärung der Passgenauigkeit bitte vor Bestellung ein 10cm-Muster anfordern. Lieferung ab Warenwert € 40,- netto frei Haus, ansonsten zzgl. € 6,95 netto Fracht. Maßstab: ca. 1:1. Stand 06/24.



| | | | | | |
|---|---|---|---|---|---|
| R 1325 | R 1092 | R 1890 | R 741 | R 1224 | R 1758 SW |
|  |  |  |  |  |  |



| | | | | | |
|---|---|---|---|---|--|
| R 894 SW | R 1763 | R 1269 SW | R 1492 SW | R 1166 | R 2120 |
|  |  |  |  |  |  |

| | | | | | |
|---|---|---|---|---|---|
| R 1704 SW | R 1070 | R 8801 SW | R 1319 SW | R 8511 | R 2379 |
|  |  |  |  |  |  |

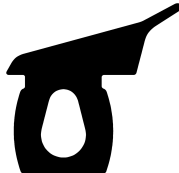

| | | | | | |
|---|---|---|---|---|---|
| R 886 SW | R 1185 | R 9562 | R 575 | R 2507 | R 1077 SW |
|  |  |  |  |  |  |

Genauere Angaben zu den Farben, Werkstoffen und Abnahmemengen siehe bitte Preisliste. Konstruktionsänderungen an den Querschnitten vorbehalten - Zur Abklärung der Passgenauigkeit bitte vor Bestellung ein 10cm-Muster anfordern. Lieferung ab Warenwert € 40,- netto frei Haus, ansonsten zzgl. € 6,95 netto Fracht. Maßstab: ca. 1:1. Stand 08/23.







| | | | | |
|---|--|---|---|---|
| R 8950 SW | | R 2550 SW | R 2550-A SW | R 5730 |
|  | |  |  |  |







| | | | | | |
|--|--|--|--|--|--|
| | | | R 9518 | | R 9537 |
| | | |  | |  |







| | | | | | |
|--|---|--|--|--|--|
| | R 9534 | | | | |
| |  | | | | |





| | | | | | |
|---|--|---|--|---|--|
| R 5729 | | R 9588 | | R 1494 | |
|  | |  | |  | |

Genauere Angaben zu den Farben, Werkstoffen und Abnahmemengen siehe bitte Preisliste. Konstruktionsänderungen an den Querschnitten vorbehalten - Zur Abklärung der Passgenauigkeit bitte vor Bestellung ein 10cm-Muster anfordern. Lieferung ab Warenwert € 40,- netto frei Haus, ansonsten zzgl. € 6,95 netto Fracht. Maßstab: ca. 1:1. Stand 06/24.





| | | | | | |
|---|---|---|---|---|---|
| R 2074 | R 2074-A sw | R 1837 | R 530 gr | R 578 sw | R 1538 sw |
|  |  |  |  |  |  |





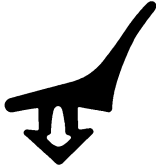

| | | | | | |
|---|---|---|--|--|--|
| R 583 | R 1964 | R 862 sw | R 861 | R 861-A sw | R 8847 sw |
|  |  |  |  |  |  |







| | | | | | |
|---|---|---|---|---|---|
| R 8721 | R 8778 sw | R 8757 sw | R 664 | R 1420 | R 817 |
|  |  |  |  |  |  |







| | | | | | |
|---|--|---|---|---|---|
| R 8698 sw | | R 714 | R 673 | R 1786 | R 2121 sw |
|  | |  |  |  |  |

Genauere Angaben zu den Farben, Werkstoffen und Abnahmemengen siehe bitte Preisliste. Konstruktionsänderungen an den Querschnitten vorbehalten - Zur Abklärung der Passgenauigkeit bitte vor Bestellung ein 10cm-Muster anfordern. Lieferung ab Warenwert € 40,- netto frei Haus, ansonsten zzgl. € 6,95 netto Fracht. Maßstab: ca. 1:1. Stand 10/23.



| | | | | | |
|---|---|---|---|---|---|
| R 1346 | R 540 | R 1454 sw | R 1425 sw | R 1164 | R 794 sw |
|  |  |  |  |  |  |

| | | | | | |
|---|---|---|---|--|--|
| R 1316 | R 8726 | R 1779 | R 2114 sw | R 1308 sw | R 1811 |
|  |  |  |  |  |  |

| | | | | | |
|---|---|---|---|---|---|
| R 2129 | R 1301 | R 1703 sw | R 5700 sw | R 8522 | R 1258 |
|  |  |  |  |  |  |

| | | | | | |
|---|---|---|---|---|---|
| R 709 sw | R 1448 sw | R 1434 sw | R 5796 sw | R 2124 sw | R 2363 |
|  |  |  |  |  |  |

Genauere Angaben zu den Farben, Werkstoffen und Abnahmemengen siehe bitte Preisliste. Konstruktionsänderungen an den Querschnitten vorbehalten - Zur Abklärung der Passgenauigkeit bitte vor Bestellung ein 10cm-Muster anfordern. Lieferung ab Warenwert € 40,- netto frei Haus, ansonsten zzgl. € 6,95 netto Fracht. Maßstab: ca. 1:1. Stand 08/23.







| | | | | | |
|---|---|--|--|--|--|
| R 2347 | R 2347-A sw | | | | |
|  |  | | | | |







| | | | | | |
|--|--|--|--|--|--|
| | | | | | |
| | | | | | |







| | | | | | |
|--|--|--|--|--|--|
| | | | | | |
| | | | | | |







| | | | | | |
|--|--|--|--|--|--|
| | | | | | |
| | | | | | |

Genauere Angaben zu den Farben, Werkstoffen und Abnahmemengen siehe bitte Preisliste. Konstruktionsänderungen an den Querschnitten vorbehalten - Zur Abklärung der Passgenauigkeit bitte vor Bestellung ein 10cm-Muster anfordern. Lieferung ab Warenwert € 40,- netto frei Haus, ansonsten zzgl. € 6,95 netto Fracht. Maßstab: ca. 1:1. Stand 12/16.



| | | | | | |
|---|---|---|---|---|---|
| R 518 SW | R 1310 SW | R 2141 SW | R 8790 SW | R 8753 SW | R 8753-A SW |
|  |  |  |  |  |  |



| | | | | | |
|---|---|---|---|---|---|
| R 8926 SW | R 1862 SW | R 1883 SW | R 9531 | R 8812 SW | R 1347 |
|  |  |  |  |  |  |



| | | | | | |
|---|---|---|---|---|---|
| R 8608 SW | R 2044 SW | R 1833 SW | R 1357 SW | R 8740 SW | R 8930 SW |
|  |  |  |  |  |  |

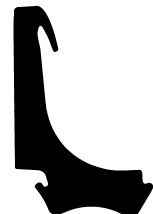

| | | | | | |
|---|---|---|---|---|---|
| R 2037 SW | R 1124 SW | R 1124-A SW | R 2071 SW | R 1476 SW | R 1093 SW |
|  |  |  |  |  |  |

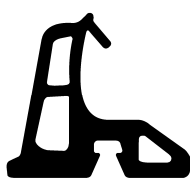
Genauere Angaben zu den Farben, Werkstoffen und Abnahmemengen siehe bitte Preisliste. Konstruktionsänderungen an den Querschnitten vorbehalten - Zur Abklärung der Passgenauigkeit bitte vor Bestellung ein 10cm-Muster anfordern. Lieferung ab Warenwert € 40,- netto frei Haus, ansonsten zzgl. € 6,95 netto Fracht. Maßstab: ca. 1:1. Stand 01/23.

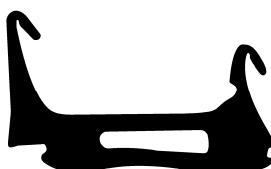





| | | | | | |
|---|--|---|--|---|--|
| R 5745 sw | | R 9538 | | R 5537 | |
|  | |  | |  | |





| | | | | | |
|---|--|--|--|--|--|
| R 2424 sw | | R 5561 | | | R 9599 |
|  | |  | | |  |





| | | | | |
|---|--|--|--|---|
| R 5528 | | | | R 5717 |
|  | | | |  |





| | | | | | |
|--|--|---|--|--|---|
| | | R 9567 sw | | | R 5550 |
| | |  | | |  |

Genauere Angaben zu den Farben, Werkstoffen und Abnahmemengen siehe bitte Preisliste. Konstruktionsänderungen an den Querschnitten vorbehalten - Zur Abklärung der Passgenauigkeit bitte vor Bestellung ein 10cm-Muster anfordern. Lieferung ab Warenwert € 40,- netto frei Haus, ansonsten zzgl. € 6,95 netto Fracht. Maßstab: ca. 1:1. Stand 06/24.

| | | | | | |
|---|---|---|---|---|---|
| R 615 gr | R 577 sw | R 2073 sw | R 1315 | R 8949 sw | R 8906 sw |
|  |  |  |  |  |  |

| | | | | | |
|--|--|--|--|--|--|
| | R 9557 | R 8915 sw | R 8916 sw | R 1376-A | R 8895 sw |
| |  |  |  |  |  |

| | | | | |
|---|---|---|---|---|
| R 8538 | R 8603 | R 8809 sw | R 8829 sw | R 8905 |
|  |  |  |  |  |

| | | | | |
|---|---|---|---|---|
| R 2326 | R 8989 sw | R 1871-A sw | R 9533 | R 5779 sw |
|  |  |  |  |  |

Genauere Angaben zu den Farben, Werkstoffen und Abnahmemengen siehe bitte Preisliste. Konstruktionsänderungen an den Querschnitten vorbehalten - Zur Abklärung der Passgenauigkeit bitte vor Bestellung ein 10cm-Muster anfordern. Lieferung ab Warenwert € 40,- netto frei Haus, ansonsten zzgl. € 6,95 netto Fracht. Maßstab: ca. 1:1. Stand 01/24.

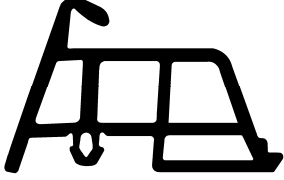
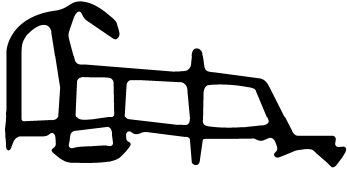



| | | |
|---|--|---|
| R 8923 SW | | R 5598 |
|  | |  |





| | | | | | |
|--|--|--|--|--|--|
| | | | | | |
| | | | | | |

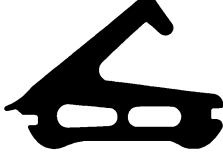





| | | | | | |
|--|--|--|--|--|--|
| | | | | | |
| | | | | | |







| | | | | | |
|--|--|--|--|--|--|
| | | | | | |
| | | | | | |

Genauere Angaben zu den Farben, Werkstoffen und Abnahmemengen siehe bitte Preisliste. Konstruktionsänderungen an den Querschnitten vorbehalten - Zur Abklärung der Passgenauigkeit bitte vor Bestellung ein 10cm-Muster anfordern. Lieferung ab Warenwert € 40,- netto frei Haus, ansonsten zzgl. € 6,95 netto Fracht. Maßstab: ca. 1:1. Stand 10/23.



| | | | |
|---|---|---|---|
| R 2111 SW | R 8685 SW | R 1459 | R 1459-B SW |
|  |  |  |  |



| | | | |
|---|---|---|--|
| R 2372 | R 2339 | R 1323 | R 2357 SW |
|  |  |  |  |



| | | | | | |
|---|---|---|---|---|---|
| R 893 gr | R 1841 SW | R 8681 SW | R 8791 SW | R 1205 | R 2018 |
|  |  |  |  |  |  |

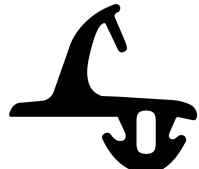

| | | | | | |
|---|---|---|---|---|---|
| R 1764 | R 1945 | R 2396 | R 5725 | R 5750 SW | R 2391 SW |
|  |  |  |  |  |  |

Genauere Angaben zu den Farben, Werkstoffen und Abnahmemengen siehe bitte Preisliste. Konstruktionsänderungen an den Querschnitten vorbehalten - Zur Abklärung der Passgenauigkeit bitte vor Bestellung ein 10cm-Muster anfordern. Lieferung ab Warenwert € 40,- netto frei Haus, ansonsten zzgl. € 6,95 netto Fracht. Maßstab: ca. 1:1. Stand 06/24.

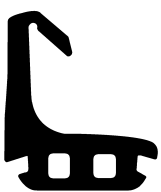





| | | | | |
|---|---|--|--|---|
| R 2011 sw | R 2011-A | | | R 5520 |
|  |  | | |  |







| | | |
|--|---|---|
| R 5695 | R 5685 sw | R 5609 sw |
|  |  |  |







| | | |
|---|---|---|
| R 5610 sw | R 2496 sw | R 5819 sw |
|  |  |  |





| | |
|---|---|
| R 5816 sw | R 5822 sw |
|  |  |

Genauere Angaben zu den Farben, Werkstoffen und Abnahmemengen siehe bitte Preisliste. Konstruktionsänderungen an den Querschnitten vorbehalten - Zur Abklärung der Passgenauigkeit bitte vor Bestellung ein 10cm-Muster anfordern. Lieferung ab Warenwert € 40,- netto frei Haus, ansonsten zzgl. € 6,95 netto Fracht. Maßstab: ca. 1:1. Stand 06/24.



| | | | | | |
|---|---|---|---|---|---|
| R 744 | R 738 sw | R 1906 sw | R 8672 | R 2055 | R 2054 |
|  |  |  |  |  |  |



| | | | | | |
|---|--|---|---|--|--|
| R 1792 | R 1488 sw | R 1917 | R 1402 | R 1767 | R 8668 |
|  |  |  |  |  |  |

| | | | | | |
|---|---|---|---|---|---|
| R 857 sw | R 1976 sw | R 1976-A sw | R 1079 | R 2027 sw | R 8862 sw |
|  |  |  |  |  |  |

| | | | | | |
|---|---|---|---|---|--|
| R 1443 sw | R 1443-A sw | R 916 | R 2358 | R 1840-B | |
|  |  |  |  |  | |

Genauere Angaben zu den Farben, Werkstoffen und Abnahmemengen siehe bitte Preisliste. Konstruktionsänderungen an den Querschnitten vorbehalten - Zur Abklärung der Passgenauigkeit bitte vor Bestellung ein 10cm-Muster anfordern. Lieferung ab Warenwert € 40,- netto frei Haus, ansonsten zzgl. € 6,95 netto Fracht. Maßstab: ca. 1:1. Stand 06/24.







| | | | | | |
|---|---|--|--|--|--|
| R 1458 SW | R 1458-A | | | | |
|  |  | | | | |







| | | | | | |
|--|--|--|--|--|--|
| | | | | R 5656 SW | R 5634 SW |
| | | | |  |  |







| | | | | | |
|--|--|--|--|--|--|
| | | | | | |
| | | | | | |







| | | | | | |
|--|--|--|--|--|--|
| | | | | | |
| | | | | | |

Genauere Angaben zu den Farben, Werkstoffen und Abnahmemengen siehe bitte Preisliste. Konstruktionsänderungen an den Querschnitten vorbehalten - Zur Abklärung der Passgenauigkeit bitte vor Bestellung ein 10cm-Muster anfordern. Lieferung ab Warenwert € 40,- netto frei Haus, ansonsten zzgl. € 6,95 netto Fracht. Maßstab: ca. 1:1. Stand 07/21.



| | | | | | |
|---|---|---|---|---|---|
| R 1211 SW | R 1831 | R 841 SW | R 1960 SW | R 8618 SW | R 598 |
|  |  |  |  |  |  |



| | | | | | |
|---|---|--|--|---|--|
| R 812 | R 8631 SW | R 1554 | R 8896 | R 640 | R 1804 |
|  |  |  |  |  |  |



| | | | | | |
|---|---|---|---|---|---|
| R 2042 SW | R 2139 SW | R 8627 SW | R 8784 SW | R 8917 SW | R 1486 |
|  |  |  |  |  |  |

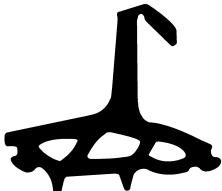

| | | | | | |
|---|---|---|---|---|---|
| R 1171 | R 8697 SW | R 2320 SW | R 1780 | R 8774 SW | R 1239 SW |
|  |  |  |  |  |  |

Genauere Angaben zu den Farben, Werkstoffen und Abnahmemengen siehe bitte Preisliste. Konstruktionsänderungen an den Querschnitten vorbehalten - Zur Abklärung der Passgenauigkeit bitte vor Bestellung ein 10cm-Muster anfordern. Lieferung ab Warenwert € 40,- netto frei Haus, ansonsten zzgl. € 6,95 netto Fracht. Maßstab: ca. 1:1. Stand 07/23.

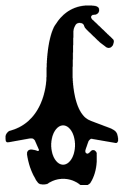



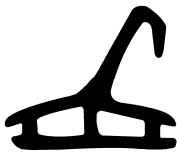

| | | |
|---|---|---|
| R 8714 SW | R 8714-A SW | R 8714-B SW |
|  |  |  |



| | | |
|--|--|---|
| R 5576 SW | | R 5811 SW |
|  | |  |

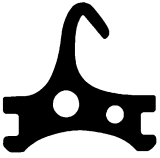

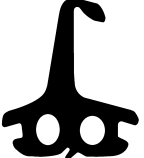
| | | | | |
|---|--|--|--|--|
| R 5580 SW | | | | R 5674 SW |
|  | | | |  ersetzt durch R 5674  verbesserte Version |



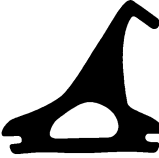

| | | | | | |
|---|---|--|--|---|--|
| R 5711 SW | R 5662 SW | | | R 5635 | |
|  |  | | |  | |

Genauere Angaben zu den Farben, Werkstoffen und Abnahmemengen siehe bitte Preisliste. Konstruktionsänderungen an den Querschnitten vorbehalten - Zur Abklärung der Passgenauigkeit bitte vor Bestellung ein 10cm-Muster anfordern. Lieferung ab Warenwert € 40,- netto frei Haus, ansonsten zzgl. € 6,95 netto Fracht. Maßstab: ca. 1:1. Stand 10/23.

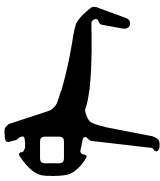
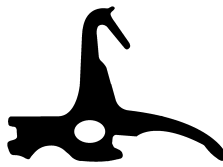





| | | | | | |
|---|---|---|---|---|---|
| R 846 | R 1372 | R 1997 | R 8535 | R 9539 sw | R 8978 sw |
|  |  |  |  |  |  |





| | | |
|--|--|--|
| R 1979 sw | R 1884 sw | R 1327 sw |
|  |  |  |





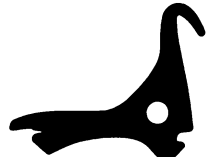

| | | | | |
|---|---|--|---|---|
| R 1953 sw | R 8718 | | R 5616 sw | R 8945 |
|  |  | |  |  |



| | | | | | |
|---|---|---|---|--|--|
| R 665 tr | R 789 | R 2479 sw | R 8942 sw | | |
|  |  |  |  | | |

Genauere Angaben zu den Farben, Werkstoffen und Abnahmemengen siehe bitte Preisliste. Konstruktionsänderungen an den Querschnitten vorbehalten - Zur Abklärung der Passgenauigkeit bitte vor Bestellung ein 10cm-Muster anfordern. Lieferung ab Warenwert € 40,- netto frei Haus, ansonsten zzgl. € 6,95 netto Fracht. Maßstab: ca. 1:1. Stand 01/24.



| | | | | | |
|---|---|---|---|---|---|
| R 1178 SW | R 952 SW | R 1303 SW | R 8702 SW | R 1810 | R 728 |
|  |  |  |  |  |  |

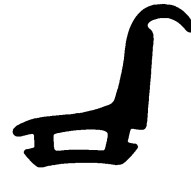

| | | | | |
|---|--|---|---|--|
| R 1856 SW | | R 8623 | R 2540 SW | R 8704 |
|  | |  |  |  |

| | | | | | |
|---|---|---|---|---|---|
| R 1994 | R 5726 | R 1986 SW | R 8520 SW | R 2010 | R 1004 |
|  |  |  |  |  |  |

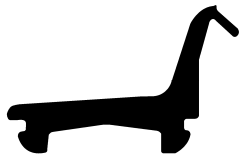
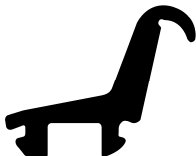
| | | |
|---|---|---|
| R 1356 SW | R 2325 SW | R 1233 SW |
|  |  |  |

Genauere Angaben zu den Farben, Werkstoffen und Abnahmemengen siehe bitte Preisliste. Konstruktionsänderungen an den Querschnitten vorbehalten - Zur Abklärung der Passgenauigkeit bitte vor Bestellung ein 10cm-Muster anfordern. Lieferung ab Warenwert € 40,- netto frei Haus, ansonsten zzgl. € 6,95 netto Fracht. Maßstab: ca. 1:1. Stand 06/24.





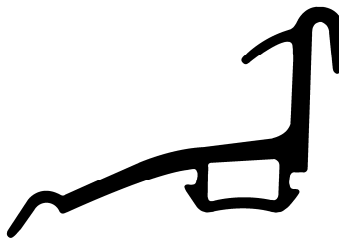

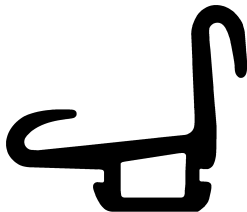
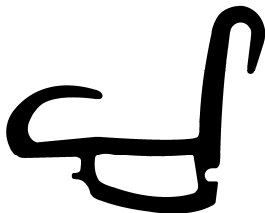
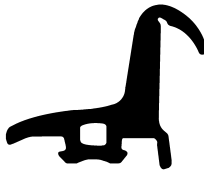
| | | |
|---|---|---|
| R 5536 sw | R 5558 | R 5721 |
|  |  |  |





| | | | | |
|--|--|---|--|---|
| | | R 5843 sw | | R 5718 sw |
| | |  | |  |



| | | | | |
|--|---|--|--|---|
| | R 5639 sw | | | R 5735 |
| |  | | |  |



| | | |
|---|---|---|
| R 3076-A sw | R 3076-B sw | R 5613 |
|  |  |  |

Genauere Angaben zu den Farben, Werkstoffen und Abnahmemengen siehe bitte Preisliste. Konstruktionsänderungen an den Querschnitten vorbehalten - Zur Abklärung der Passgenauigkeit bitte vor Bestellung ein 10cm-Muster anfordern. Lieferung ab Warenwert € 40,- netto frei Haus, ansonsten zzgl. € 6,95 netto Fracht. Maßstab: ca. 1:1. Stand 12/23.

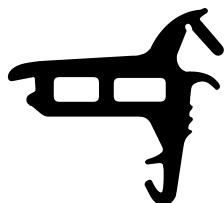

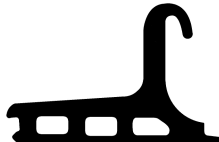

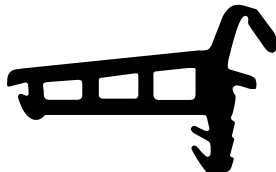
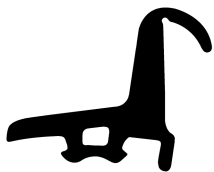
| | | | | | |
|---|---|---|---|---|---|
| R 8710 SW | R 8710-A SW | R 8748 SW | R 8878 | R 8754 SW | R 8863 SW |
|  |  |  |  |  |  |



| | | | |
|---|---|---|---|
| R 8792 | R 8872 | R 8802 SW | R 8977 SW |
|  |  |  |  |





| | | |
|---|---|---|
| R 9598 | R 5502 | R 9576 |
|  |  |  |

| | | |
|---|---|---|
| R 2185-A | R 8986 SW | R 8839 |
|  |  |  |

Genauere Angaben zu den Farben, Werkstoffen und Abnahmemengen siehe bitte Preisliste. Konstruktionsänderungen an den Querschnitten vorbehalten - Zur Abklärung der Passgenauigkeit bitte vor Bestellung ein 10cm-Muster anfordern. Lieferung ab Warenwert € 40,- netto frei Haus, ansonsten zzgl. € 6,95 netto Fracht. Maßstab: ca. 1:1. Stand 06/24.



| | | | | | |
|---|---|---|--|---|---|
| R 2033 | R 2136 | R 2126 sw | | R 1271 sw | R 1955 sw |
|  |  |  | |  |  |







| | | | | | |
|---|---|---|--|--|--|
| R 848 | R 1836 sw | R 2353 sw | | | |
|  |  |  | | | |



| | | | | | |
|---|---|--|---|--|---|
| R 2015 | R 877 | R 1349 | R 1349-A sw | | R 5778 gr |
|  |  |  ersetzt durch R 1349-A |  verbesserte Version | |  |



| | | | | | |
|--|--|--|--|---|--|
| | | | | R 8963 | |
| | | | |  | |

Genauere Angaben zu den Farben, Werkstoffen und Abnahmemengen siehe bitte Preisliste. Konstruktionsänderungen an den Querschnitten vorbehalten - Zur Abklärung der Passgenauigkeit bitte vor Bestellung ein 10cm-Muster anfordern. Lieferung ab Warenwert € 40,- netto frei Haus, ansonsten zzgl. € 6,95 netto Fracht. Maßstab: ca. 1:1. Stand 08/23.



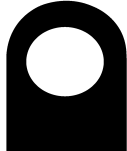
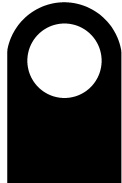



| | | | | | |
|---|---|--|--|--|---|
| R 712 | R 573 gr | | | | R 531 |
|  |  | | | |  |





| | | | | | |
|---|---|---|---|---|---|
| R 988 | R 1151 sw | R 1188 sw | R 1159 | R 962 sw | R 957 sw |
|  |  |  |  |  |  |







| | | | | | |
|--|---|---|---|---|---|
| | R 666 | R 1820 | R 1885 | R 9527 | R 8899 |
| |  |  |  |  |  |







| | | | | | |
|--|---|---|--|--|---|
| | R 5594 | R 8929 | | | R 991 sw |
| |  |  | | |  |

Genauere Angaben zu den Farben, Werkstoffen und Abnahmemengen siehe bitte Preisliste. Konstruktionsänderungen an den Querschnitten vorbehalten - Zur Abklärung der Passgenauigkeit bitte vor Bestellung ein 10cm-Muster anfordern. Lieferung ab Warenwert € 40,- netto frei Haus, ansonsten zzgl. € 6,95 netto Fracht. Maßstab: ca. 1:1. Stand 06/24.

| | | | | | |
|---|---|---|---|---|---|
| R 1038 SW | R 1181 SW | R 960 SW | R 960-A | R 1065 SW | R 1066 SW |
|  |  |  |  |  |  |

| | | | | | |
|--|---|---|---|---|---|
| | R 1556 | R 713 | R 1177 SW | R 1174 SW | R 1585 |
| |  |  |  |  |  |

| | | | | | |
|---|---|---|---|---|---|
| R 2509 | R 8545 | R 1284 | R 1069 | R 1126 | R 8731 SW |
|  |  |  |  |  |  |



| | | | | | |
|---|---|---|---|---|---|
| R 501 SW | R 533 | R 2524 | R 965 | R 562 | R 1899 |
|  |  |  |  |  |  |

Genauere Angaben zu den Farben, Werkstoffen und Abnahmemengen siehe bitte Preisliste. Konstruktionsänderungen an den Querschnitten vorbehalten - Zur Abklärung der Passgenauigkeit bitte vor Bestellung ein 10cm-Muster anfordern. Lieferung ab Warenwert € 40,- netto frei Haus, ansonsten zzgl. € 6,95 netto Fracht. Maßstab: ca. 1:1. Stand 06/24.





| | | | | | |
|---|--|--|--|--|--|
| R 5646 | | | | | |
|  | | | | | |







| | | | | | |
|--|--|---|--|--|--|
| | | R 5813 SW | | | |
| | |  | | | |





| | | | | | |
|--|--|--|--|--|--|
| | | | | | |
| | | | | | |

| | | | | | |
|--|---|--|--|---|--|
| | R 5714 | | | R 5766 | |
| |  | | |  | |

Genauere Angaben zu den Farben, Werkstoffen und Abnahmemengen siehe bitte Preisliste. Konstruktionsänderungen an den Querschnitten vorbehalten - Zur Abklärung der Passgenauigkeit bitte vor Bestellung ein 10cm-Muster anfordern. Lieferung ab Warenwert € 40,- netto frei Haus, ansonsten zzgl. € 6,95 netto Fracht. Maßstab: ca. 1:1. Stand 10/23.



| | | | | | |
|---|---|---|---|--|--|
| R 1988 SW | R 1147 SW | R 1281 | R 1772 | | |
|  |  |  |  | | |

| | | | | | |
|---|---|---|---|---|---|
| R 1942 | R 1776 SW | R 8519 | R 2028 | R 8979 | R 8855 |
|  |  |  |  |  |  |

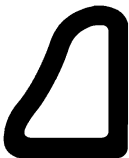
| | | | | |
|---|---|---|--|---|
| R 8983 | R 506 SW | R 541 | | R 1391 |
|  |  |  | |  |



| | | | | | |
|---|---|--|--|--|--|
| R 1295 | R 2178 | | | | |
|  |  | | | | |

Genauere Angaben zu den Farben, Werkstoffen und Abnahmemengen siehe bitte Preisliste. Konstruktionsänderungen an den Querschnitten vorbehalten - Zur Abklärung der Passgenauigkeit bitte vor Bestellung ein 10cm-Muster anfordern. Lieferung ab Warenwert € 40,- netto frei Haus, ansonsten zzgl. € 6,95 netto Fracht. Maßstab: ca. 1:1. Stand 01/23.

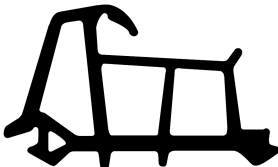
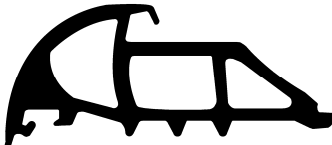
| | | |
|---|---|---|
| R 989 sw | R 979 gr | R 980 gr |
|  |  |  |

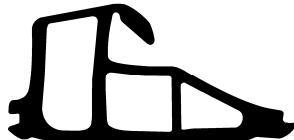
| | | |
|---|--|---|
| R 8882 sw | R 8886 sw | R 8908 sw |
|  |  |  |

| | | |
|---|--|---|
| R 8910 | | R 5708 sw |
|  | |  |

| | | | |
|---|---|--|---|
| R 1580 sw | R 9556 | | R 2113 |
|  |  | |  |



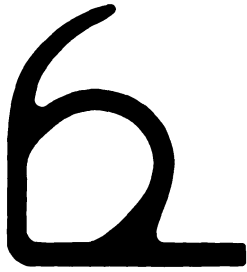



Genauere Angaben zu den Farben, Werkstoffen und Abnahmemengen siehe bitte Preisliste. Konstruktionsänderungen an den Querschnitten vorbehalten - Zur Abklärung der Passgenauigkeit bitte vor Bestellung ein 10cm-Muster anfordern. Lieferung ab Warenwert € 40,- netto frei Haus, ansonsten zzgl. € 6,95 netto Fracht. Maßstab: ca. 1:1. Stand 01/23.







| | |
|---|--|
| R 1312 | |
|  | |







| | |
|--|--|
| | |
| | |







| | |
|--|--|
| | |
| | |

Genauere Angaben zu den Farben, Werkstoffen und Abnahmemengen siehe bitte Preisliste. Konstruktionsänderungen an den Querschnitten vorbehalten - Zur Abklärung der Passgenauigkeit bitte vor Bestellung ein 10cm-Muster anfordern. Lieferung ab Warenwert € 40,- netto frei Haus, ansonsten zzgl. € 6,95 netto Fracht. Maßstab: ca. 1:1. Stand 04/14.







| | | | | | |
|---|---|---|---|---|---|
| R 859 sw | R 2531 sw | R 2529 sw | R 2529-A sw | R 1959 sw | R 2541 sw |
|  |  |  |  |  |  |







| | | | | | |
|---|---|---|---|---|---|
| R 1293 sw | R 1422 sw | R 1561 sw | R 8745 | R 1456 | R 8700 sw |
|  |  |  |  |  |  |







| | | | | | |
|---|---|---|---|---|---|
| R 1008 sw/w | R 1416 | R 2532 sw | R 1424 sw | R 1424-A sw/w | R 1905 sw |
|  |  |  |  |  |  |



| | | | | | |
|---|---|---|---|---|---|
| R 1969 | R 2533 sw | R 5830 sw | R 2530 gr/sw | R 8795 gr/sw | R 1712 gr/sw |
|  |  |  |  |  |  |

Genauere Angaben zu den Farben, Werkstoffen und Abnahmemengen siehe bitte Preisliste. Konstruktionsänderungen an den Querschnitten vorbehalten - Zur Abklärung der Passgenauigkeit bitte vor Bestellung ein 10cm-Muster anfordern. Lieferung ab Warenwert € 40,- netto frei Haus, ansonsten zzgl. € 6,95 netto Fracht. Maßstab: ca. 1:1. Stand 06/24.

| | | | | | |
|---|---|---|---|---|---|
| R 8859 sw/w | R 8865 sw/w | R 5583 sw | R 5675 lichtgrau | R 5798 lichtgrau | R 5807 sw |
|  |  |  |  |  |  |



| | | | | | |
|---|---|---|---|---|---|
| R 5825 sw | R 8975 lichtgrau | R 5736 sw | R 9558 sw | R 1194 | R 5552 gr |
|  |  |  |  |  |  |

| | | | | | |
|---|---|---|---|---|---|
| R 5628 sw | R 9524 sw | R 5548 sw | R 5541 sw | R 2531-A sw | R 9554 sw |
|  |  |  |  |  |  |

| | | |
|---|---|---|
| R 5547 | R 5566 sw | R 5712 |
|  |  |  |

Genauere Angaben zu den Farben, Werkstoffen und Abnahmemengen siehe bitte Preisliste. Konstruktionsänderungen an den Querschnitten vorbehalten - Zur Abklärung der Passgenauigkeit bitte vor Bestellung ein 10cm-Muster anfordern. Lieferung ab Warenwert € 40,- netto frei Haus, ansonsten zzgl. € 6,95 netto Fracht. Maßstab: ca. 1:1. Stand 10/23.





| | | | | | |
|--|--|--|---|--|--|
| | | | R 710 sw | | |
| | | |  | | |







| | | | | | |
|---|--|---|--|--|--|
| R 5848 lgr | | R 5847 sw | | | |
|  | |  | | | |

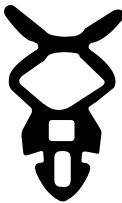



| | | | | | |
|--|--|--|--|--|--|
| | | | | | |
| | | | | | |







| | | | | | |
|--|--|--|--|---|--|
| | | | | R 5839 sw | |
| | | | |  | |

Genauere Angaben zu den Farben, Werkstoffen und Abnahmemengen siehe bitte Preisliste. Konstruktionsänderungen an den Querschnitten vorbehalten - Zur Abklärung der Passgenauigkeit bitte vor Bestellung ein 10cm-Muster anfordern. Lieferung ab Warenwert € 40,- netto frei Haus, ansonsten zzgl. € 6,95 netto Fracht. Maßstab: ca. 1:1. Stand 06/24.

| | | | | | |
|---|---|---|---|---|---|
| R 2542 gr | R 5504 gr | R 2331 gr | R 1429 gr | R 890 | R 5517 |
|  |  |  |  |  |  |







| | | | | | |
|---|--|---|---|---|---|
| R 1137 gr | R 1145 gr | | R 5747 sw | R 5665 gr | R 1433 gr |
|  |  ersetzt durch R 1145 |  verbesserte Version |  |  |  |

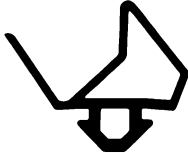





| | | | | | |
|---|---|--|---|---|---|
| R 8856 sw | R 5559 | | R 5731 lgr | R 8834 | R 8814 gr |
|  |  | |  |  |  |







| | | | | | |
|---|---|---|---|--|---|
| R 685 sw | R 8607 sw | R 8833 sw | R 8771 w | R 5638 lgr | |
|  |  |  |  |  ersetzt durch R 5638 |  verbesserte Version |

Genauere Angaben zu den Farben, Werkstoffen und Abnahmemengen siehe bitte Preisliste. Konstruktionsänderungen an den Querschnitten vorbehalten - Zur Abklärung der Passgenauigkeit bitte vor Bestellung ein 10cm-Muster anfordern. Lieferung ab Warenwert € 40,- netto frei Haus, ansonsten zzgl. € 6,95 netto Fracht. Maßstab: ca. 1:1. Stand 09/23.





| | | | | |
|---|---|--|--|---|
| R 1586 gr | R 1366 | | | R 2084 sw |
|  |  | | |  |





| | | | | | |
|---|---|---|---|---|---|
| R 921 sw | R 5641 gr | R 929 sw | R 1559 gr/sw | R 1999 | R 1808 |
|  |  |  |  |  |  |





| | | | | | |
|---|---|---|---|---|---|
| R 9514 sw | R 961 gr | R 2354 gr | R 1365 | R 1983 | R 1393 |
|  |  |  |  |  |  |





| | | | | | |
|---|---|---|---|---|---|
| R 1816 | R 1855 | R 2322 sw | R 5716 sw | R 8951 sw | R 8504 |
|  |  |  |  |  |  |

Genauere Angaben zu den Farben, Werkstoffen und Abnahmemengen siehe bitte Preisliste. Konstruktionsänderungen an den Querschnitten vorbehalten - Zur Abklärung der Passgenauigkeit bitte vor Bestellung ein 10cm-Muster anfordern. Lieferung ab Warenwert € 40,- netto frei Haus, ansonsten zzgl. € 6,95 netto Fracht. Maßstab: ca. 1:1. Stand 07/23.







| | | | | | |
|---|---|--|---|---|---|
| R 8867 | R 2312 | | R 5809 | R 8788 sw | R 9522 gr |
|  |  | |  |  |  |







| | | | | | |
|---|---|---|---|---|--|
| R 977 | R 982 gr | R 1300 | R 8937 sw | R 943 | |
|  |  |  |  |  | |





| | | | | |
|---|---|---|---|---|
| R 1798 sw | R 1789 | R 1790 | R 550 | R 8735 |
|  |  |  |  |  |





| | | | | | |
|---|--|---|---|---|---|
| R 8884 | | R 1902 | R 8666 sw | R 969 sw | R 983 |
|  | |  |  |  |  |

Genauere Angaben zu den Farben, Werkstoffen und Abnahmemengen siehe bitte Preisliste. Konstruktionsänderungen an den Querschnitten vorbehalten - Zur Abklärung der Passgenauigkeit bitte vor Bestellung ein 10cm-Muster anfordern. Lieferung ab Warenwert € 40,- netto frei Haus, ansonsten zzgl. € 6,95 netto Fracht. Maßstab: ca. 1:1. Stand 08/23.







| | | | | | |
|---|---|---|---|---|---|
| R 1426 gr | R 1713 sw | R 1428 sw | R 8881 | R 1232 | R 1332 |
|  |  |  |  |  |  |





| | | | | | |
|---|---|---|---|---|---|
| R 1276 | R 2058 sw | R 2390 | R 1421 | R 564 sw | R 2369 sw |
|  |  |  |  |  |  |







| | | | | |
|---|--|---|---|---|
| R 5814 sw | | R 2182 | R 2181 | R 2097-A sw |
|  | |  |  |  |







| | | | | |
|---|---|---|---|---|
| R 737 | R 1595 | R 981 | R 1981 sw | R 2097 |
|  |  |  |  |  |

Genauere Angaben zu den Farben, Werkstoffen und Abnahmemengen siehe bitte Preisliste. Konstruktionsänderungen an den Querschnitten vorbehalten - Zur Abklärung der Passgenauigkeit bitte vor Bestellung ein 10cm-Muster anfordern. Lieferung ab Warenwert € 40,- netto frei Haus, ansonsten zzgl. € 6,95 netto Fracht. Maßstab: ca. 1:1. Stand 08/23.





| | | | | | |
|---|---|---|---|---|---|
| R 2510 | R 2078 | R 8786 sw | R 5818 sw | R 585 sw | R 1813 |
|  |  |  |  |  |  |

| | | | | | |
|---|--|---|---|---|---|
| R 2537 | | R 2128 sw | R 1894 sw | R 8850 | R 5606 sw |
|  | |  |  |  |  |

| | | | | | |
|---|---|---|---|---|---|
| R 1053 | R 8636 w | R 636 sw | R 679 | R 504 | R 888 |
|  |  |  |  |  |  |

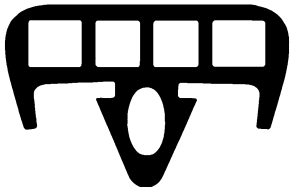
| | | | | | |
|---|---|---|---|---|---|
| R 1852 sw/w | R 5767 | R 1128 | R 1146 | R 5709 | R 8985 |
|  |  |  |  |  |  |

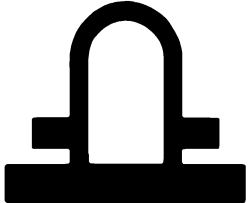

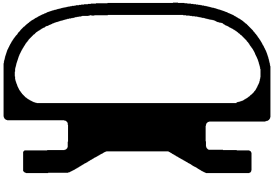
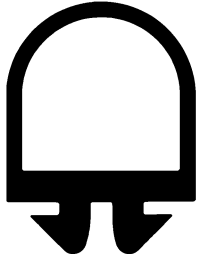
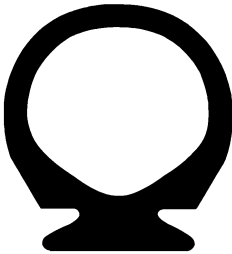
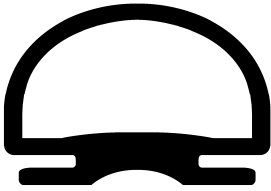
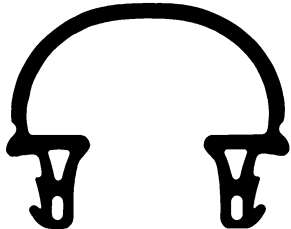
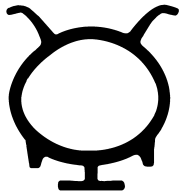

Genauere Angaben zu den Farben, Werkstoffen und Abnahmemengen siehe bitte Preisliste. Konstruktionsänderungen an den Querschnitten vorbehalten - Zur Abklärung der Passgenauigkeit bitte vor Bestellung ein 10cm-Muster anfordern. Lieferung ab Warenwert € 40,- netto frei Haus, ansonsten zzgl. € 6,95 netto Fracht. Maßstab: ca. 1:1. Stand 10/23.

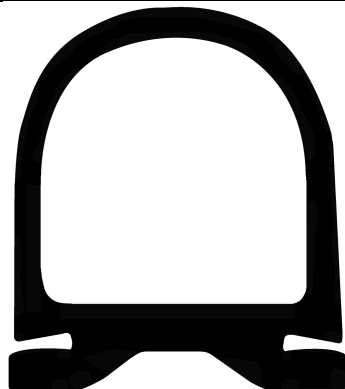
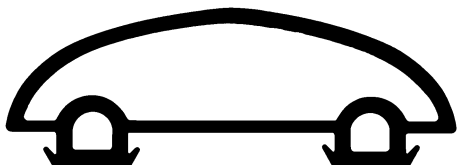
| | | |
|---|---|---|
| R 1212 gr/sw | R 5795 sw | R 2371 sw |
|  |  |  |
| R 990 | R 1896 sw | R 1163 sw |
|  |  |  |
| R 994 sw | R 2019 | R 8813 sw |
|  |  |  |
| R 1371 sw | | R 5775 sw |
|  | |  |

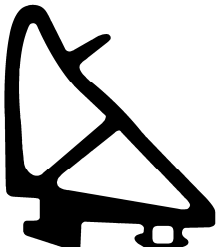
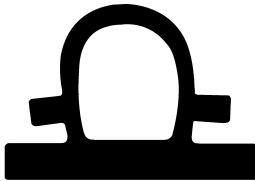
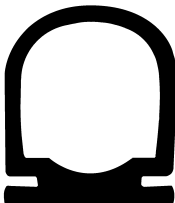
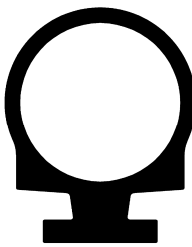
Genauere Angaben zu den Farben, Werkstoffen und Abnahmemengen siehe bitte Preisliste. Konstruktionsänderungen an den Querschnitten vorbehalten - Zur Abklärung der Passgenauigkeit bitte vor Bestellung ein 10cm-Muster anfordern. Lieferung ab Warenwert € 40,- netto frei Haus, ansonsten zzgl. € 6,95 netto Fracht. Maßstab: ca. 1:1. Stand 10/21.

| | |
|---|--|
| R 9584 | R 953 |
|  |  |

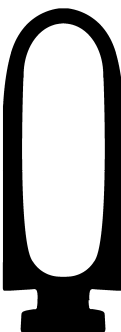
| | | | |
|--|---|--|--|
| R 5755 | R 5600 sw | R 5523 | R 5740 sw |
|  |  |  |  |

| | | | |
|---|---|--|---|
| R 5617 | R 5524 | R 5626 | R 5569 |
|  |  |  |  |

Genauere Angaben zu den Farben, Werkstoffen und Abnahmemengen siehe bitte Preisliste. Konstruktionsänderungen an den Querschnitten vorbehalten - Zur Abklärung der Passgenauigkeit bitte vor Bestellung ein 10cm-Muster anfordern. Lieferung ab Warenwert € 40,- netto frei Haus, ansonsten zzgl. € 6,95 netto Fracht. Maßstab: ca. 1:1. Stand 06/24.

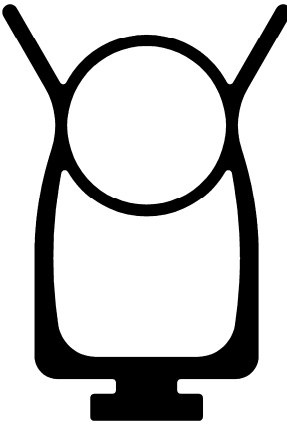
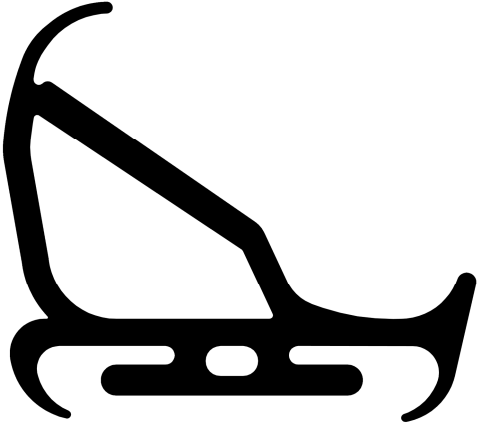
| R 5741 | R 5748 |
|---|--|
|  |  |

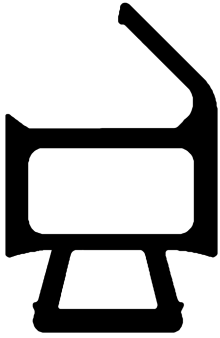
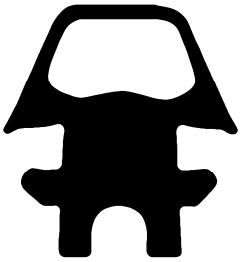
| | R 5764 | | R 5770 sw |
|--|---|--|---|
| |  | |  |



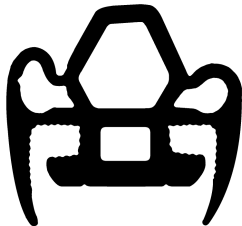
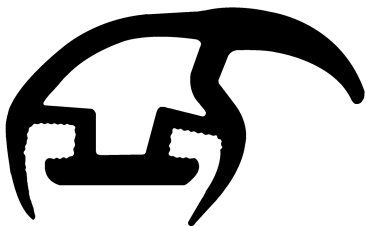

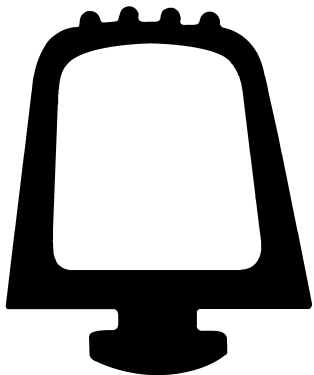
Genauere Angaben zu den Farben, Werkstoffen und Abnahmemengen siehe bitte Preisliste. Konstruktionsänderungen an den Querschnitten vorbehalten - Zur Abklärung der Passgenauigkeit bitte vor Bestellung ein 10cm-Muster anfordern. Lieferung ab Warenwert € 40,- netto frei Haus, ansonsten zzgl. € 6,95 netto Fracht. Maßstab: ca. 1:1. Stand 10/23.

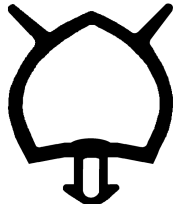
| | | |
|---|--|--|
| R 5786 | | R 5787 |
|  | |  |



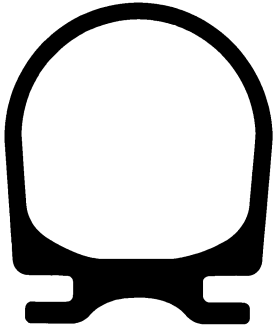
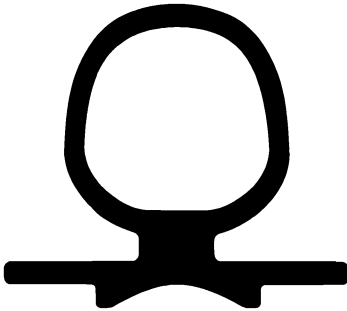
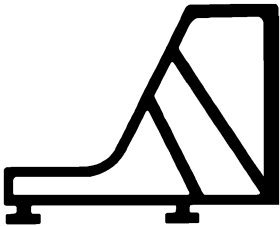

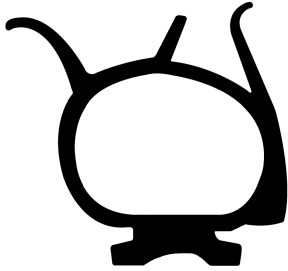
| | | |
|--|--|--|
| R 5824 sw | | |
|  | | |

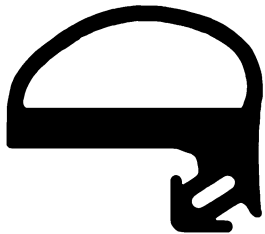





| | | | |
|--|--|--|--|
| | | R 5788 | |
| | |  | |







Genauere Angaben zu den Farben, Werkstoffen und Abnahmemengen siehe bitte Preisliste. Konstruktionsänderungen an den Querschnitten vorbehalten - Zur Abklärung der Passgenauigkeit bitte vor Bestellung ein 10cm-Muster anfordern. Lieferung ab Warenwert € 40,- netto frei Haus, ansonsten zzgl. € 6,95 netto Fracht. Maßstab: ca. 1:1. Stand 10/22.







| | | | |
|---|---|--|---|
| R 1138 sw | | R 1005 | |
|  | |  | |
| R 1824 | | R 1563 | |
|  | |  | |
| R 8722 | R 8880 | R 8973 | R 2116 |
|  |  |  |  |

Genauere Angaben zu den Farben, Werkstoffen und Abnahmemengen siehe bitte Preisliste. Konstruktionsänderungen an den Querschnitten vorbehalten - Zur Abklärung der Passgenauigkeit bitte vor Bestellung ein 10cm-Muster anfordern. Lieferung ab Warenwert € 40,- netto frei Haus, ansonsten zzgl. € 6,95 netto Fracht. Maßstab: ca. 1:1. Stand 06/24.





| | | | | | |
|---|---|---|---|--|---|
| R 1055 | R 831 sw | R 1054 sw | R 1919 | | R 880 sw |
|  |  |  |  | |  |



| | | | | | |
|---|---|---|---|---|---|
| R 1892 sw | R 1490 sw | R 587 sw | R 671 sw/w | R 2004 sw | R 1929 sw |
|  |  |  |  |  |  |





| | | | | | |
|---|---|---|---|---|---|
| R 524 sw | R 539 | R 844 sw | R 1435 gr | R 8695 | R 1289 |
|  |  |  |  |  |  |

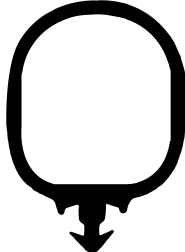

| | | | | | |
|---|---|---|---|---|---|
| R 731 sw/w | R 731-A sw | R 731-B sw/w | R 8821 sw | R 599 sw | R 1794 sw |
|  |  |  |  |  |  |

Genauere Angaben zu den Farben, Werkstoffen und Abnahmemengen siehe bitte Preisliste. Konstruktionsänderungen an den Querschnitten vorbehalten - Zur Abklärung der Passgenauigkeit bitte vor Bestellung ein 10cm-Muster anfordern. Lieferung ab Warenwert € 40,- netto frei Haus, ansonsten zzgl. € 6,95 netto Fracht. Maßstab: ca. 1:1. Stand 06/23.







| | | | | | |
|---|---|--|---|--|---|
| R 720 sw | R 1102 sw | | R 2497 sw | | R 2498 sw |
|  |  | |  | |  |







| | | | | |
|---|--|---|--|--|
| R 9582 | | R 5630 | | R 5784 |
|  | |  | |  |







| | | | | | |
|---|---|--|---|---|--|
| R 5670 lgr/sw | R 5671 sw | | R 5672 | R 5673 lgr/sw | |
|  |  | |  |  | |







| | | | | | |
|---|--|--|---|--|---|
| R 5723 | | | R 5692 sw | | R 9505 |
|  | | |  | |  |

Genauere Angaben zu den Farben, Werkstoffen und Abnahmemengen siehe bitte Preisliste. Konstruktionsänderungen an den Querschnitten vorbehalten - Zur Abklärung der Passgenauigkeit bitte vor Bestellung ein 10cm-Muster anfordern. Lieferung ab Warenwert € 40,- netto frei Haus, ansonsten zzgl. € 6,95 netto Fracht. Maßstab: ca. 1:1. Stand 06/24.



| | | | | | |
|---|---|---|---|---|---|
| R 2142 SW | R 1048 SW | R 838 SW | R 735 SW | R 2315 | R 922 SW |
|  |  |  |  |  |  |



| | | | | | |
|---|---|---|---|---|---|
| R 1962 | R 944 SW | R 944-A SW | R 1427 SW | R 1827 SW | R 2131 SW |
|  |  |  |  |  |  |

| | | | | | |
|---|---|---|---|---|---|
| R 1142 SW | R 839 SW | R 930 | R 2376 SW | R 907 | R 732 SW |
|  |  |  |  |  |  |



| | | | | | |
|---|---|---|---|---|---|
| R 1182 SW | R 1326 | R 684 SW | R 8626 SW | R 8653 SW | R 8625 SW |
|  |  |  |  |  |  |

Genauere Angaben zu den Farben, Werkstoffen und Abnahmemengen siehe bitte Preisliste. Konstruktionsänderungen an den Querschnitten vorbehalten - Zur Abklärung der Passgenauigkeit bitte vor Bestellung ein 10cm-Muster anfordern. Lieferung ab Warenwert € 40,- netto frei Haus, ansonsten zzgl. € 6,95 netto Fracht. Maßstab: ca. 1:1. Stand 05/24.







| | | | | | |
|---|--|--|---|--|---|
| R 1136 sw | | | R 8635 sw | | R 8645 |
|  | | |  | |  |







| | | | | | |
|--|---|---|--|--|--|
| | R 958 gr | R 954 | | | |
| |  |  | | | |





| | | | | | |
|--|--|--|--|---|--|
| | | | | R 5797 sw | |
| | | | |  | |





| | | | | |
|---|--|---|--|---|
| R 1823 | | R 1075 | | R 819 |
|  | |  | |  |

Genauere Angaben zu den Farben, Werkstoffen und Abnahmemengen siehe bitte Preisliste. Konstruktionsänderungen an den Querschnitten vorbehalten - Zur Abklärung der Passgenauigkeit bitte vor Bestellung ein 10cm-Muster anfordern. Lieferung ab Warenwert € 40,- netto frei Haus, ansonsten zzgl. € 6,95 netto Fracht. Maßstab: ca. 1:1. Stand 06/23.





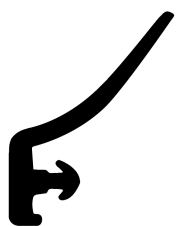

| | | | | | |
|---|---|---|---|---|---|
| R 813 SW | R 1354 | R 660 SW | R 694 SW | R 1220 SW | R 1756 SW |
|  |  |  |  |  |  |







| | | | | | |
|---|---|---|---|---|---|
| R 547 SW | R 625 | R 1270 | R 8659 SW | R 653 | R 1063 SW |
|  |  |  |  |  |  |







| | | | | | |
|---|---|---|---|--|---|
| R 1544 SW | R 2029 | R 1297 SW | R 8693 | | R 809 |
|  |  |  |  | |  |







| | | | | | |
|---|---|---|---|--|---|
| R 551 SW | R 551-A | R 2513 | R 510 | | R 8817 SW |
|  |  |  |  | |  |

Genauere Angaben zu den Farben, Werkstoffen und Abnahmemengen siehe bitte Preisliste. Konstruktionsänderungen an den Querschnitten vorbehalten - Zur Abklärung der Passgenauigkeit bitte vor Bestellung ein 10cm-Muster anfordern. Lieferung ab Warenwert € 40,- netto frei Haus, ansonsten zzgl. € 6,95 netto Fracht. Maßstab: ca. 1:1. Stand 06/24.





| | | | | | |
|---|---|---|---|---|---|
| R 1253 SW | R 661 SW | R 759 SW | R 759-A SW | R 1385 SW | R 2393 SW |
|  |  |  |  |  |  |





| | | | | | |
|---|--|---|---|---|---|
| R 1716 SW | R 760 SW | R 8632 SW | R 1056 SW | R 8604 SW | R 1842 SW |
|  |  |  |  |  |  |



| | | | | | |
|---|---|---|---|---|---|
| R 1975 | R 1431 | R 1907 SW | R 1098 SW | R 1714 SW | R 2399 SW |
|  |  |  |  |  |  |



| | | | | | |
|---|---|---|---|---|---|
| R 1552 | R 584 SW | R 1260 SW | R 745 | R 787 | R 1846 |
|  |  |  |  |  |  |

Genauere Angaben zu den Farben, Werkstoffen und Abnahmemengen siehe bitte Preisliste. Konstruktionsänderungen an den Querschnitten vorbehalten - Zur Abklärung der Passgenauigkeit bitte vor Bestellung ein 10cm-Muster anfordern. Lieferung ab Warenwert € 40,- netto frei Haus, ansonsten zzgl. € 6,95 netto Fracht. Maßstab: ca. 1:1. Stand 06/23.



| | | | | | |
|---|---|---|---|--|---|
| R 9530 sw | R 5521 sw | R 5820 sw | R 9507 sw | | R 5706 sw |
|  |  |  |  | |  |





| | | | | | |
|---|--|---|--|--|--|
| R 9583 | R 5535 | R 5677 sw | R 5627 | | R 5724 |
|  |  |  |  | |  |







| | | | | | |
|---|--|---|--|---|--|
| R 5789 gr | | R 5633 | | R 5620 sw | |
|  | |  | |  | |





| | | | | | |
|---|--|---|--|---|--|
| R 8887 sw | | R 5654 sw | | R 9547 sw | |
|  | |  | |  | |

Genauere Angaben zu den Farben, Werkstoffen und Abnahmemengen siehe bitte Preisliste. Konstruktionsänderungen an den Querschnitten vorbehalten - Zur Abklärung der Passgenauigkeit bitte vor Bestellung ein 10cm-Muster anfordern. Lieferung ab Warenwert € 40,- netto frei Haus, ansonsten zzgl. € 6,95 netto Fracht. Maßstab: ca. 1:1. Stand 10/23.



| | | | | | |
|--|---|--|---|--|---|
| | R 5812 sw | | R 8820 | | R 782 |
| |  | |  | |  |

| | | | | | |
|---|--|--|--|--|---|
| R 1042 | | R 8875 sw | R 8770 sw | R 8808 sw | R 840 |
|  | |  |  |  |  |







| | | | | | |
|---|---|---|---|---|---|
| R 8854 sw | R 8990 sw | R 5653 sw | R 8991 sw | R 8816 sw | R 1017 sw |
|  |  |  |  |  |  |







| | | | | | |
|---|---|---|--|---|---|
| R 1214 sw | R 8524 sw | R 1296 sw | | R 8972 sw | R 8674 sw |
|  |  |  | |  |  |







Genauere Angaben zu den Farben, Werkstoffen und Abnahmemengen siehe bitte Preisliste. Konstruktionsänderungen an den Querschnitten vorbehalten - Zur Abklärung der Passgenauigkeit bitte vor Bestellung ein 10cm-Muster anfordern. Lieferung ab Warenwert € 40,- netto frei Haus, ansonsten zzgl. € 6,95 netto Fracht. Maßstab: ca. 1:1. Stand 01/23.







| R 1879 sw | R 5773 | R 8843 |
|---|--|---|
|  |  |  |

Genauere Angaben zu den Farben, Werkstoffen und Abnahmemengen siehe bitte Preisliste. Konstruktionsänderungen an den Querschnitten vorbehalten - Zur Abklärung der Passgenauigkeit bitte vor Bestellung ein 10cm-Muster anfordern. Lieferung ab Warenwert € 40,- netto frei Haus, ansonsten zzgl. € 6,95 netto Fracht. Maßstab: ca. 1:1. Stand 01/24.



| | | | | | |
|---|---|---|---|---|---|
| R 659 SW | R 634 SW | R 1238 SW | R 1217 SW | R 1217-A SW | R 609 SW |
|  |  |  |  |  |  |



| | | | | | |
|---|---|---|---|---|--|
| R 2314 SW | R 2408 SW | R 1191 SW | R 1229 SW | R 2146 SW | R 758 SW |
|  |  |  |  |  |  |





| | | | | | |
|---|---|---|---|---|---|
| R 1247 SW | R 756 SW | R 1044 | R 828 | R 658 SW | R 8649 |
|  |  |  |  |  |  |





| | | | | | |
|---|---|---|---|---|---|
| R 1266 SW | R 1026 | R 761 SW | R 761-A SW | R 1141 SW | R 8874 SW |
|  |  |  |  |  |  |

Genauere Angaben zu den Farben, Werkstoffen und Abnahmemengen siehe bitte Preisliste. Konstruktionsänderungen an den Querschnitten vorbehalten - Zur Abklärung der Passgenauigkeit bitte vor Bestellung ein 10cm-Muster anfordern. Lieferung ab Warenwert € 40,- netto frei Haus, ansonsten zzgl. € 6,95 netto Fracht. Maßstab: ca. 1:1. Stand 08/22.







| | | | | | |
|---|---|--|--|---|--|
| R 830 SW | R 9553 SW | | | R 5545 SW | |
|  |  | | |  | |







| | | | | | |
|---|--|---|--|--|--|
| R 9506 SW | | R 5512 | | | R 8987 |
|  | |  | | |  |







| | | | | | |
|---|---|--|---|--|---|
| R 5728 SW | R 5828 SW | | R 5564 SW | | R 8958 SW |
|  |  | |  | |  |





| | | | | | |
|---|--|---|--|---|---|
| R 5505 | | R 5556 | | R 5693 SW | R 8965 SW |
|  | |  | |  |  |

Genauere Angaben zu den Farben, Werkstoffen und Abnahmemengen siehe bitte Preisliste. Konstruktionsänderungen an den Querschnitten vorbehalten - Zur Abklärung der Passgenauigkeit bitte vor Bestellung ein 10cm-Muster anfordern. Lieferung ab Warenwert € 40,- netto frei Haus, ansonsten zzgl. € 6,95 netto Fracht. Maßstab: ca. 1:1. Stand 09/23.







| | | | | | |
|---|---|---|---|---|---|
| R 1167 SW | R 1718 SW | R 754 SW | R 1715 SW | R 1717 SW | R 757 SW |
|  |  |  |  |  |  |







| | | | | | |
|---|---|---|---|---|--|
| R 1318 | R 1386 SW | R 8703 SW | R 753 SW | R 682 SW | R 8536 SW |
|  |  |  |  |  |  |







| | | | | | |
|---|---|---|---|---|---|
| R 1196 SW | R 8521 | R 8901 SW | R 753-A SW | R 8860 SW | R 8612 SW |
|  |  |  |  |  |  |







| | | | | | |
|---|---|---|---|--|---|
| R 8539 SW | R 1140 | R 2123 SW | R 8921 SW | | R 8943 SW |
|  |  |  |  | |  |

Genauere Angaben zu den Farben, Werkstoffen und Abnahmemengen siehe bitte Preisliste. Konstruktionsänderungen an den Querschnitten vorbehalten - Zur Abklärung der Passgenauigkeit bitte vor Bestellung ein 10cm-Muster anfordern. Lieferung ab Warenwert € 40,- netto frei Haus, ansonsten zzgl. € 6,95 netto Fracht. Maßstab: ca. 1:1. Stand 06/23.







| | | | | | |
|---|---|---|---|---|---|
| R 561 SW | R 1221 SW | R 2394 SW | R 1105 SW | R 1218 SW | R 1121 SW |
|  |  |  |  |  |  |







| | | | | | |
|---|---|---|---|---|---|
| R 1215 SW | R 1085 SW | R 678 SW | R 678-A SW | R 1851 SW | R 5574 |
|  |  |  |  |  |  |





| | | | | | |
|---|---|---|---|---|---|
| R 1399 | R 608 | R 8828 SW | R 8602 SW | R 9516 SW | R 9517 |
|  |  |  |  |  |  |





| | | | | | |
|---|---|---|---|--|---|
| R 784 SW | R 778 SW | R 2348 SW | R 2332 SW | R 8730 SW | R 8730 SW |
|  |  |  |  |  ersetzt durch R 8730 |  verbesserte Version |

Genauere Angaben zu den Farben, Werkstoffen und Abnahmemengen siehe bitte Preisliste. Konstruktionsänderungen an den Querschnitten vorbehalten - Zur Abklärung der Passgenauigkeit bitte vor Bestellung ein 10cm-Muster anfordern. Lieferung ab Warenwert € 40,- netto frei Haus, ansonsten zzgl. € 6,95 netto Fracht. Maßstab: ca. 1:1. Stand 06/24.







| | | | | | |
|---|---|---|---|---|---|
| R 5621 SW | R 2169 SW | R 786 SW | R 786-A SW | R 8861 SW | R 1853 SW/W |
|  |  |  |  |  |  |







| | | | | | |
|---|---|---|---|---|---|
| R 8825 SW | R 9549 SW | R 5806 SW | R 8931 SW | R 9571 | R 1549 |
|  |  |  |  |  |  |



| | | | | | |
|---|--|---|---|---|---|
| R 5759 SW | | R 9577 | R 9591 | R 5608 | R 8922 SW |
|  | |  |  |  |  |







| | | | | |
|---|---|---|--|---|
| R 8961 | R 9570 | R 9569 | R 5682 | R 9573 SW |
|  |  |  |  ersetzt durch R 5682 |  verbesserte Version |

Genauere Angaben zu den Farben, Werkstoffen und Abnahmemengen siehe bitte Preisliste. Konstruktionsänderungen an den Querschnitten vorbehalten - Zur Abklärung der Passgenauigkeit bitte vor Bestellung ein 10cm-Muster anfordern. Lieferung ab Warenwert € 40,- netto frei Haus, ansonsten zzgl. € 6,95 netto Fracht. Maßstab: ca. 1:1. Stand 06/24.





| | | | | | |
|---|---|---|---|---|---|
| R 643 | R 1441 sw | R 579 sw | R 567 sw | R 2038 | R 1771 |
|  |  |  |  |  |  |

| | | | | | |
|---|---|---|---|---|---|
| R 604 | R 5694 | R 8684 | R 5780 sw | R 2323 | R 5791 sw |
|  |  |  |  |  |  |







| | | | | | |
|--|---|---|---|--|--|
| | R 1131 | R 8852 sw | R 8769 sw | | |
| |  |  |  | | |







| | | | | | |
|---|---|---|---|---|---|
| R 8877 w | R 1787 sw | R 1438 sw | R 889 gr | R 1562 | R 770 |
|  |  |  |  |  |  |







Genauere Angaben zu den Farben, Werkstoffen und Abnahmemengen siehe bitte Preisliste. Konstruktionsänderungen an den Querschnitten vorbehalten - Zur Abklärung der Passgenauigkeit bitte vor Bestellung ein 10cm-Muster anfordern. Lieferung ab Warenwert € 40,- netto frei Haus, ansonsten zzgl. € 6,95 netto Fracht. Maßstab: ca. 1:1. Stand 10/23.







| R 1821 SW | | R 1382 SW | R 1198 | | R 5821 SW |
|---|--|---|---|--|---|
|  | |  |  | |  |

Genauere Angaben zu den Farben, Werkstoffen und Abnahmemengen siehe bitte Preisliste. Konstruktionsänderungen an den Querschnitten vorbehalten - Zur Abklärung der Passgenauigkeit bitte vor Bestellung ein 10cm-Muster anfordern. Lieferung ab Warenwert € 40,- netto frei Haus, ansonsten zzgl. € 6,95 netto Fracht. Maßstab: ca. 1:1. Stand 05/23.







| | | | | | |
|---|---|---|---|---|---|
| R 1761 SW | R 1723 SW | R 1720 SW | R 1721 | R 8541 W | R 1719 SW |
|  |  |  |  |  |  |







| | | | | | |
|---|---|---|---|---|---|
| R 1087 SW | R 767 SW | R 1086 SW | R 8644 SW | R 8644-A | R 1722 SW |
|  |  |  |  |  |  |





| | | | | | |
|---|---|---|---|---|---|
| R 1759 SW | R 1089 SW | R 1088 SW | R 554 SW | R 8692 SW | R 8660 SW |
|  |  |  |  |  |  |







| | | | | | |
|---|---|---|---|---|---|
| R 2060 SW | R 1219 SW | R 2156 SW | R 8844 SW | R 8671 SW | R 8716 |
|  |  |  |  |  |  |

Genauere Angaben zu den Farben, Werkstoffen und Abnahmemengen siehe bitte Preisliste. Konstruktionsänderungen an den Querschnitten vorbehalten - Zur Abklärung der Passgenauigkeit bitte vor Bestellung ein 10cm-Muster anfordern. Lieferung ab Warenwert € 40,- netto frei Haus, ansonsten zzgl. € 6,95 netto Fracht. Maßstab: ca. 1:1. Stand 07/20.



| | | | | | |
|---|---|---|---|---|---|
| R 5644 SW | R 5618 SW | R 5844 SW | R 5562 SW | R 5664 SW | R 5508 SW |
|  |  |  |  |  |  |



| | | | | | |
|---|---|---|--|--|--|
| R 5587 | R 5586 | R 5588 | R 5611 | R 5650 | R 5539 |
|  |  |  |  |  |  |

| | | | | | |
|---|---|--|---|---|---|
| R 5511 SW | R 5506 SW | | R 1933 | R 5838 SW | R 5827 SW |
|  |  | |  |  |  |







| | | | | | |
|---|---|---|---|---|---|
| R 5722 SW | R 5684 SW | R 5585 | R 5589 SW | R 5584 | R 5507 |
|  |  |  |  |  |  |







Genauere Angaben zu den Farben, Werkstoffen und Abnahmemengen siehe bitte Preisliste. Konstruktionsänderungen an den Querschnitten vorbehalten - Zur Abklärung der Passgenauigkeit bitte vor Bestellung ein 10cm-Muster anfordern. Lieferung ab Warenwert € 40,- netto frei Haus, ansonsten zzgl. € 6,95 netto Fracht. Maßstab: ca. 1:1. Stand 06/24.







| R 5592 | R 5593 | | |
|---|---|--|--|
|  |  | | |







| R 5845 SW | | R 5823 SW | |
|---|--|---|--|
|  | |  | |

Genauere Angaben zu den Farben, Werkstoffen und Abnahmemengen siehe bitte Preisliste. Konstruktionsänderungen an den Querschnitten vorbehalten - Zur Abklärung der Passgenauigkeit bitte vor Bestellung ein 10cm-Muster anfordern. Lieferung ab Warenwert € 40,- netto frei Haus, ansonsten zzgl. € 6,95 netto Fracht. Maßstab: ca. 1:1. Stand 06/24.







| | | | | | |
|---|---|---|---|---|---|
| R 2101 | R 2324 sw | R 8827 | R 9526 sw | R 8848 sw | R 8849 sw |
|  |  |  |  |  |  |





| | | | | | |
|---|---|---|---|---|---|
| R 763 | R 769 | R 8525 | R 9532 sw | R 1022 | R 1022-A sw |
|  |  |  |  |  |  |







| | | | | | |
|---|---|---|---|---|---|
| R 8677 sw | R 9543 sw | R 8680 sw/w | R 8994 sw | R 8996 sw | R 8696 sw |
|  |  |  |  |  |  |





| | | | | | |
|---|---|---|---|---|---|
| R 8699 gr/sw | R 2831 sw | R 8941 sw | R 9545 sw | R 9597 | R 8715 |
|  |  |  |  |  |  |

Genauere Angaben zu den Farben, Werkstoffen und Abnahmemengen siehe bitte Preisliste. Konstruktionsänderungen an den Querschnitten vorbehalten - Zur Abklärung der Passgenauigkeit bitte vor Bestellung ein 10cm-Muster anfordern. Lieferung ab Warenwert € 40,- netto frei Haus, ansonsten zzgl. € 6,95 netto Fracht. Maßstab: ca. 1:1. Stand 01/24.







| | | | | | |
|---|---|---|---|---|---|
| R 775 sw | R 764 sw | R 1009 sw | R 5841 sw | R 8637 | R 1103 |
|  |  |  |  |  |  |







| | | | | | |
|---|---|---|--|---|--|
| R 1793 sw/w | R 772 sw | R 773 sw | | R 771 sw | R 5532 gr |
|  |  |  | |  |  |







| | | | | | |
|---|---|---|---|---|---|
| R 2100 | R 2047 | R 1184 sw | R 695 sw | R 568 sw | R 790 |
|  |  |  |  |  |  |







| | | | | | |
|---|---|---|--|---|--|
| R 768 sw | R 1225 | R 1223 sw | | R 1709 | |
|  |  |  | |  | |

Genauere Angaben zu den Farben, Werkstoffen und Abnahmemengen siehe bitte Preisliste. Konstruktionsänderungen an den Querschnitten vorbehalten - Zur Abklärung der Passgenauigkeit bitte vor Bestellung ein 10cm-Muster anfordern. Lieferung ab Warenwert € 40,- netto frei Haus, ansonsten zzgl. € 6,95 netto Fracht. Maßstab: ca. 1:1. Stand 10/23.





| | | | | | |
|---|---|---|---|---|---|
| R 544 | R 766 SW | R 765 SW | R 1010 SW | R 545 | R 681 SW |
|  |  |  |  |  |  |







| | | | | | |
|---|---|---|---|---|--|
| R 1797 SW | R 1094 SW | R 1094-A SW | R 2112 SW | R 1440 SW | R 955 SW |
|  |  |  |  |  |  |







| | | | | | |
|---|---|---|---|---|---|
| R 1968 SW | R 1970 SW | R 1213 SW | R 2093 SW | R 5533 SW | R 948 SW |
|  |  |  |  |  |  |







| | | | | | |
|---|---|---|---|---|---|
| R 1384 | R 8925 SW | R 2328 SW | R 2329 SW | R 8527 | R 8662 SW |
|  |  |  |  |  |  |

Genauere Angaben zu den Farben, Werkstoffen und Abnahmemengen siehe bitte Preisliste. Konstruktionsänderungen an den Querschnitten vorbehalten - Zur Abklärung der Passgenauigkeit bitte vor Bestellung ein 10cm-Muster anfordern. Lieferung ab Warenwert € 40,- netto frei Haus, ansonsten zzgl. € 6,95 netto Fracht. Maßstab: ca. 1:1. Stand 01/24.



| | | | | | |
|---|---|---|---|---|--|
| R 5553 SW | R 8663 SW | R 2103 SW | R 8819 SW | R 8885 SW | |
|  |  |  |  |  | |



| | | | | | |
|---|---|---|--|---|---|
| R 8734 | R 8913 SW | R 8927 SW | R 5567 SW | R 5581 | R 8858 SW |
|  |  |  |  |  |  |





| | | | | | |
|---|---|---|---|---|---|
| R 1706 | R 762 | R 9552 sw/w | R 1052 | R 5834 SW | R 5543 |
|  |  |  |  |  |  |



| | | | | | |
|---|---|---|---|---|---|
| R 9536 | R 8737 | R 5596 | R 5591 SW | R 5590 | R 1991 |
|  |  |  |  |  |  |

Genauere Angaben zu den Farben, Werkstoffen und Abnahmemengen siehe bitte Preisliste. Konstruktionsänderungen an den Querschnitten vorbehalten - Zur Abklärung der Passgenauigkeit bitte vor Bestellung ein 10cm-Muster anfordern. Lieferung ab Warenwert € 40,- netto frei Haus, ansonsten zzgl. € 6,95 netto Fracht. Maßstab: ca. 1:1. Stand 06/24.



| | | | | | |
|---|--|---|--|--|---|
| R 5603 gr | | R 5657 sw | | | R 5701 |
|  | |  | | |  |

| | | | | | |
|--|---|--|---|--|--|
| | R 5738 | | R 5669 | | |
| |  | |  | | |

| | | | | | |
|---|--|---|--|---|---|
| R 5658 | | R 5751 | | R 5777 sw | R 5707 sw |
|  | |  | |  |  |



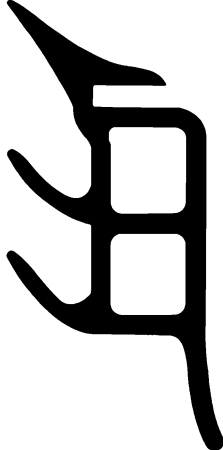

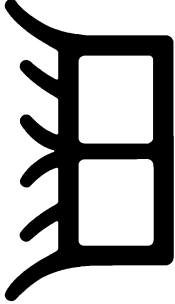

| | | | | | |
|--|--|---|--|---|--|
| | | R 5686 sw | | R 5679 | |
| | |  | |  | |





Genauere Angaben zu den Farben, Werkstoffen und Abnahmemengen siehe bitte Preisliste. Konstruktionsänderungen an den Querschnitten vorbehalten - Zur Abklärung der Passgenauigkeit bitte vor Bestellung ein 10cm-Muster anfordern. Lieferung ab Warenwert € 40,- netto frei Haus, ansonsten zzgl. € 6,95 netto Fracht. Maßstab: ca. 1:1. Stand 06/24.







| | | | |
|---|--|--|---|
| R 1701 | | | R 8947 SW |
|  | | |  |







| | | | |
|--|--|--|---|
| | | | R 1320 |
| | | |  |

Genauere Angaben zu den Farben, Werkstoffen und Abnahmemengen siehe bitte Preisliste. Konstruktionsänderungen an den Querschnitten vorbehalten - Zur Abklärung der Passgenauigkeit bitte vor Bestellung ein 10cm-Muster anfordern. Lieferung ab Warenwert € 40,- netto frei Haus, ansonsten zzgl. € 6,95 netto Fracht. Maßstab: ca. 1:1. Stand 12/14.





| | | | | | |
|---|---|---|---|---|---|
| R 632 | R 1095 sw | R 2009 | R 1403 sw | R 1388 sw | R 1952 gr/sw |
|  |  |  |  |  |  |





| | | | | | |
|---|---|---|---|--|---|
| R 5760 w | R 2311 sw | R 1437 sw | R 1822 sw | | R 8988 |
|  |  |  |  | |  |







| | | | | | |
|---|---|---|---|---|---|
| R 1007 sw | R 2065 | R 8505 sw | R 8506 sw | R 1051 sw | R 5510 |
|  |  |  |  |  |  |





| | | | | | |
|---|---|---|---|---|---|
| R 1940 | R 1468 sw | R 1930 sw | R 1941 | R 1932 sw | R 1471 sw |
|  |  |  |  |  |  |

Genauere Angaben zu den Farben, Werkstoffen und Abnahmemengen siehe bitte Preisliste. Konstruktionsänderungen an den Querschnitten vorbehalten - Zur Abklärung der Passgenauigkeit bitte vor Bestellung ein 10cm-Muster anfordern. Lieferung ab Warenwert € 40,- netto frei Haus, ansonsten zzgl. € 6,95 netto Fracht. Maßstab: ca. 1:1. Stand 09/23.







| | | | | | |
|---|---|---|---|--|---|
| R 1460 SW | R 774 SW | R 1096 SW | R 5629 SW | | R 1030 |
|  |  |  |  | |  |







| | | | | | |
|---|--|---|--|---|---|
| R 752 | | R 1313 | | R 1762 SW | R 1860 |
|  | |  | |  |  |







| | | | | | |
|---|---|---|---|---|---|
| R 1939 SW | R 8647 SW | R 3022 SW | R 8938 SW | R 9523 SW | R 8741 |
|  |  |  |  |  |  |







| | | | | | |
|---|---|--|---|--|---|
| R 1241 SW | R 1977 | | R 8713 | | R 8783 SW |
|  |  | |  | |  |

Genauere Angaben zu den Farben, Werkstoffen und Abnahmemengen siehe bitte Preisliste. Konstruktionsänderungen an den Querschnitten vorbehalten - Zur Abklärung der Passgenauigkeit bitte vor Bestellung ein 10cm-Muster anfordern. Lieferung ab Warenwert € 40,- netto frei Haus, ansonsten zzgl. € 6,95 netto Fracht. Maßstab: ca. 1:1. Stand 08/22.

| | | | | | |
|---|---|---|---|---|---|
| R 1207 sw | R 2543 | R 631 gr/sw/w | R 2535 sw | R 5762 | R 1931 |
|  |  |  |  |  |  |

| | | | | | |
|--|---|---|---|---|--|
| R 5727 | R 2090 sw | R 9548 | R 2031 | R 755 | R 1799 |
|  |  |  |  |  |  |

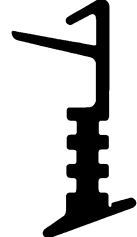
| | | | | | |
|---|---|---|---|---|---|
| R 8614 | R 8907 | R 8532 | R 5703 | R 8853 | R 5804 sw |
|  |  |  |  |  |  |



| | | | | | |
|---|---|---|---|---|---|
| R 2180 sw | R 8543 sw | R 1041 | R 779 | R 780 | R 5573 |
|  |  |  |  |  |  |





Genauere Angaben zu den Farben, Werkstoffen und Abnahmemengen siehe bitte Preisliste. Konstruktionsänderungen an den Querschnitten vorbehalten - Zur Abklärung der Passgenauigkeit bitte vor Bestellung ein 10cm-Muster anfordern. Lieferung ab Warenwert € 40,- netto frei Haus, ansonsten zzgl. € 6,95 netto Fracht. Maßstab: ca. 1:1. Stand 06/24.

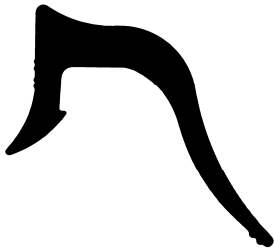

| | | | |
|--|--|---|--|
| | | R 5840 SW | |
| | |  | |

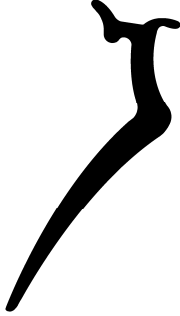
| | | | |
|--|--|--|--|
| | | | |
| | | | |







Genauere Angaben zu den Farben, Werkstoffen und Abnahmemengen siehe bitte Preisliste. Konstruktionsänderungen an den Querschnitten vorbehalten - Zur Abklärung der Passgenauigkeit bitte vor Bestellung ein 10cm-Muster anfordern. Lieferung ab Warenwert € 40,- netto frei Haus, ansonsten zzgl. € 6,95 netto Fracht. Maßstab: ca. 1:1. Stand 10/23.





| R 2000 | R 5765 sw | R 8831 gr/sw | R 1878 |
|---|---|---|---|
|  |  |  |  |



| R 5578 | R 5746 | R 5577 | R 8997 sw |
|--|--|--|--|
|  |  |  |  |







| R 8678 | | | R 5754 |
|---|--|--|---|
|  | | |  |

Genauere Angaben zu den Farben, Werkstoffen und Abnahmemengen siehe bitte Preisliste. Konstruktionsänderungen an den Querschnitten vorbehalten - Zur Abklärung der Passgenauigkeit bitte vor Bestellung ein 10cm-Muster anfordern. Lieferung ab Warenwert € 40,- netto frei Haus, ansonsten zzgl. € 6,95 netto Fracht. Maßstab: ca. 1:1. Stand 06/24.





| R 2070 sw | R 1667 sw | R 1944 sw | R 1668 | R 1669 | R 1555 |
|--|--|--|--|--|--|
|  4 x 2mm |  5 x 3mm |  5,5 x 2mm |  6 x 3mm |  7 x 4mm |  7 x 5mm |





| R 1670 | R 1671 | | | R 1672 | R 1673 |
|--|--|--|--|---|---|
|  8 x 4mm |  8 x 5mm | | |  10 x 6mm |  10 x 7mm |

| R 1674 | | | R 8518 | | |
|---|--|--|---|--|--|
|  12 x 8mm | | |  | | |

| R 9600 sw | R 1697 | R 1692 sw | R 1693 | R 1694 sw | R 9601 sw |
|--|--|--|--|--|--|
|  2mm |  3mm |  4mm |  5mm |  6mm |  7mm |

Genauere Angaben zu den Farben, Werkstoffen und Abnahmemengen siehe bitte Preisliste. Konstruktionsänderungen an den Querschnitten vorbehalten - Zur Abklärung der Passgenauigkeit bitte vor Bestellung ein 10cm-Muster anfordern. Lieferung ab Warenwert € 40,- netto frei Haus, ansonsten zzgl. € 6,95 netto Fracht. Maßstab: ca. 1:1. Stand 07/23.

| | | | | | |
|--|--|---|--|---|---|
| R 1695 | R 9602 sw | R 1696 | | R 9604 sw | R 9605 sw |
|  8mm |  9mm |  10mm | |  12mm |  13mm |

| | | | | | |
|--|---|---|---|--|---|
| | R 9607 sw | R 9608 sw | R 9609 sw | | R 9611 sw |
| |  15mm |  16mm |  18mm | |  20mm |

| | | | | | |
|--|--|--|--|--|--|
| | | | | | |
| | | | | | |

| | | | | | |
|--|--|--|--|--|--|
| | | | | | |
| | | | | | |



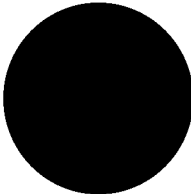

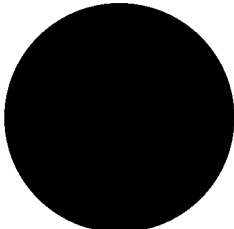
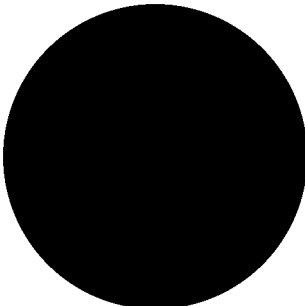

Genauere Angaben zu den Farben, Werkstoffen und Abnahmemengen siehe bitte Preisliste. Konstruktionsänderungen an den Querschnitten vorbehalten - Zur Abklärung der Passgenauigkeit bitte vor Bestellung ein 10cm-Muster anfordern. Lieferung ab Warenwert € 40,- netto frei Haus, ansonsten zzgl. € 6,95 netto Fracht. Maßstab: ca. 1:1. Stand 09/20.







| | |
|--|---|
| | R 9613 sw |
| |  25mm |





| | |
|--|---|
| R 9614 sw | R 9615 sw |
|  30mm |  40mm |





| | |
|--|--|
| | |
| | |

Genauere Angaben zu den Farben, Werkstoffen und Abnahmemengen siehe bitte Preisliste. Konstruktionsänderungen an den Querschnitten vorbehalten - Zur Abklärung der Passgenauigkeit bitte vor Bestellung ein 10cm-Muster anfordern. Lieferung ab Warenwert € 40,- netto frei Haus, ansonsten zzgl. € 6,95 netto Fracht. Maßstab: ca. 1:1. Stand 09/20.





| R 1639 | R 1640 | R 1641 sw | R 1642 | R 1643 | R 1644 sw |
|--|--|---|--|--|---|
|  2 x 5mm |  2 x 8mm |  2 x 10mm |  3 x 5mm |  3 x 8mm |  3 x 10mm |

| R 1638 | R 1653 | R 1645 | R 1646 sw | R 1647 sw | R 1648 sw |
|---|--|--|---|---|---|
|  3 x 20mm |  4 x 4mm |  4 x 8mm |  4 x 10mm |  4 x 15mm |  4 x 20mm |

| R 1654 | R 1649 sw | R 1650 sw | R 1651 sw | R 1652 sw |
|--|---|---|---|---|
|  5 x 5mm |  5 x 10mm |  5 x 15mm |  5 x 20mm |  5 x 30mm |

| R 1655 | | R 1656 | R 1657 | R 1659 | |
|--|--|--|--|--|--|
|  6 x 6mm | |  8 x 8mm |  10 x 10mm |  12 x 10mm | |

Genauere Angaben zu den Farben, Werkstoffen und Abnahmemengen siehe bitte Preisliste. Konstruktionsänderungen an den Querschnitten vorbehalten - Zur Abklärung der Passgenauigkeit bitte vor Bestellung ein 10cm-Muster anfordern. Lieferung ab Warenwert € 40,- netto frei Haus, ansonsten zzgl. € 6,95 netto Fracht. Maßstab: ca. 1:1. Stand 07/23.

| | | | | |
|--|--|--|--|--|
| R 9621 sw | | R 9623 sw | R 9624 sw | R 9625 sw |
|  15 x 10mm | |  15 x 30mm |  20 x 10mm |  20 x 15mm |

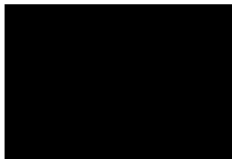

| | | | |
|--|--|--|--|
| | R 9627 sw | | |
| |  25 x 10mm | | |

| | | |
|--|--|--|
| | | R 9631 sw |
| | |  30 x 10mm |

| | | |
|--|--|--|
| R 9632 sw | | |
|  30 x 20mm | | |

Genauere Angaben zu den Farben, Werkstoffen und Abnahmemengen siehe bitte Preisliste. Konstruktionsänderungen an den Querschnitten vorbehalten - Zur Abklärung der Passgenauigkeit bitte vor Bestellung ein 10cm-Muster anfordern. Lieferung ab Warenwert € 40,- netto frei Haus, ansonsten zzgl. € 6,95 netto Fracht. Maßstab: ca. 1:1. Stand 10/20.



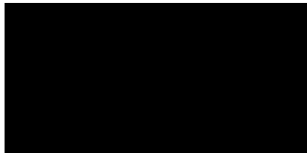
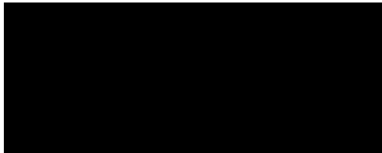

| | | |
|--|--|--|
| | | |
| | | |



| | | |
|--|--|--|
| | R 9639 sw | R 9640 sw |
| |  40 x 10mm |  40 x 15mm |

| | | |
|--|--|--|
| R 9641 sw | R 9646 sw | |
|  40 x 20mm |  50 x 20mm | |

| | | |
|--|--|---|
| | | R 1881 |
| | |  7 x 37mm |

Genauere Angaben zu den Farben, Werkstoffen und Abnahmemengen siehe bitte Preisliste. Konstruktionsänderungen an den Querschnitten vorbehalten - Zur Abklärung der Passgenauigkeit bitte vor Bestellung ein 10cm-Muster anfordern. Lieferung ab Warenwert € 40,- netto frei Haus, ansonsten zzgl. € 6,95 netto Fracht. Maßstab: ca. 1:1. Stand 10/20.





| R 1676 | R 1678 | R 1679 | | R 1680 | R 1682 sw |
|--|--|--|--|---|--|
|  9 x 5,5mm (1mm) |  10 x 10mm (2mm) |  12 x 12mm (2mm) | |  15 x 15mm (2,5mm) |  20 x 20mm (3mm) |







| R 1683 | R 1685 | | | | |
|--|---|--|--|--|--|
|  20 x 20mm (4mm) |  25 x 25mm (5mm) | | | | |







| | | | | | |
|--|--|--|--|--|--|
| | | | | | |
| | | | | | |







| | | | | | |
|--|--|--|--|--|--|
| | | | | | |
| | | | | | |

Genauere Angaben zu den Farben, Werkstoffen und Abnahmemengen siehe bitte Preisliste. Konstruktionsänderungen an den Querschnitten vorbehalten - Zur Abklärung der Passgenauigkeit bitte vor Bestellung ein 10cm-Muster anfordern. Lieferung ab Warenwert € 40,- netto frei Haus, ansonsten zzgl. € 6,95 netto Fracht. Maßstab: ca. 1:1. Stand 07/23.







| R 1600 sw | R 1601 sw | | R 1602 | R 1603 sw | R 1604 sw |
|---|--|--|---|--|---|
|  3 x 8mm (1mm / 6mm) |  3 x 10mm (1mm / 8mm) | |  3,5 x 8mm (1,2mm / 6mm) |  3,5 x 10mm (1,2mm / 8mm) |  4 x 8mm (1,5mm / 6mm) |





| R 1605 sw | R 1606 | R 511 | R 1607 | R 1608 sw | R 1609 sw |
|--|---|--|--|---|--|
|  4 x 10mm (1,5mm / 8mm) |  4 x 12mm (1,5mm / 10mm) |  4,8 x 10mm (1,7mm / 8,5mm) |  5 x 10mm (1,8mm / 8mm) |  5 x 12mm (1,8mm / 10mm) |  5 x 10mm (2mm / 8mm) |





| R 1610 sw | R 1611 | R 1612 | R 1613 sw | R 1614 sw | R 1615 sw |
|--|--|---|--|---|--|
|  5x 12mm (2mm / 10mm) |  6 x 10mm (2,5mm / 8mm) |  6 x 12mm (2,5mm / 10mm) |  6 x 10mm (3mm / 8mm) |  6 x 12mm (3mm / 10mm) |  8 x 10mm (4mm / 8mm) |







| R 1616 sw | R 1625 | R 1617 sw | R 1618 sw | R 1619 sw | R 1250 sw |
|---|---|---|---|--|---|
|  8 x 12mm (4mm / 10mm) |  10 x 12mm (4mm / 9mm) |  9 x 12mm (5mm / 10mm) |  10 x 10mm (6mm / 8,5mm) |  10 x 12mm (6mm / 10mm) |  10,5 x 10mm (7,5mm / 8,5mm) |

Genauere Angaben zu den Farben, Werkstoffen und Abnahmemengen siehe bitte Preisliste. Konstruktionsänderungen an den Querschnitten vorbehalten - Zur Abklärung der Passgenauigkeit bitte vor Bestellung ein 10cm-Muster anfordern. Lieferung ab Warenwert € 40,- netto frei Haus, ansonsten zzgl. € 6,95 netto Fracht. Maßstab: ca. 1:1. Stand 07/23.



| R 1620 sw | R 1621 sw | R 1624 sw | R 1622 sw | R 1623 sw | R 1627 |
|---|---|---|---|---|---|
|  |  |  |  |  |  |
| 12 x 12mm (8mm / 10mm) | 15 x 12mm (10mm / 9mm) | 15 x 15mm (10mm / 12mm) | 18 x 15mm (12mm / 12mm) | 18 x 18mm (12mm / 15mm) | 22 x 20mm (12mm / 15mm) |



| R 1626 | R 8960 | R 8775 gr | R 8548 |
|---|---|---|---|
|  |  |  |  |
| 24 x 25mm (12,4mm / 19,2mm) | 24 x 25mm (12,4mm / 20,2mm) | | |





| R 563 | R 867 | R 1826 | R 1032 sw | R 798 |
|---|---|---|---|---|
|  |  |  |  |  |



| R 2014 | R 1359 | R 1362 | R 1453 | R 1031 | R 1252 sw |
|---|---|---|---|---|---|
|  |  |  |  |  |  |

Genauere Angaben zu den Farben, Werkstoffen und Abnahmemengen siehe bitte Preisliste. Konstruktionsänderungen an den Querschnitten vorbehalten - Zur Abklärung der Passgenauigkeit bitte vor Bestellung ein 10cm-Muster anfordern. Lieferung ab Warenwert € 40,- netto frei Haus, ansonsten zzgl. € 6,95 netto Fracht. Maßstab: ca. 1:1. Stand 07/23.



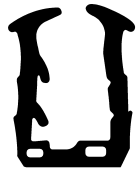

| | | | | | |
|---|--|---|--|--|---|
| R 9560 | | R 5526 | | | R 5660 sw |
|  | |  | | |  |







| | | |
|--|--|---|
| R 5691 | | R 5688 |
|  | |  |

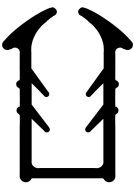

| | | | | |
|---|---|---|---|---|
| R 5713 | R 5503 sw | R 5680 sw | R 5509 | R 5689 |
|  |  |  |  |  |

| | | | | |
|---|--|---|--|---|
| R 5817 sw | | R 5540 | | R 9566 |
|  | |  | |  |

Genauere Angaben zu den Farben, Werkstoffen und Abnahmemengen siehe bitte Preisliste. Konstruktionsänderungen an den Querschnitten vorbehalten - Zur Abklärung der Passgenauigkeit bitte vor Bestellung ein 10cm-Muster anfordern. Lieferung ab Warenwert € 40,- netto frei Haus, ansonsten zzgl. € 6,95 netto Fracht. Maßstab: ca. 1:1. Stand 06/24.



| | | | | | |
|---|--|---|---|--|---|
| R 5737 SW | | R 5781 | R 5763 SW | | R 8727 |
|  | |  |  | |  |



| | | | | | |
|--|--|---|--|---|---|
| R 1216 SW | R 1888 SW | R 8764 | R 8512 | R 1129 | R 8992 SW |
|  |  |  |  |  |  |

| | | |
|---|--|---|
| R 1966 | | R 5668 |
|  | |  |

| | | | |
|--|--|--|--|
| | | | R 5800 SW |
| | | |  |

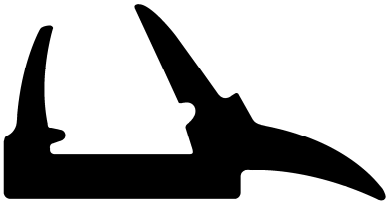

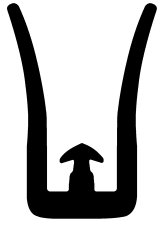
Genauere Angaben zu den Farben, Werkstoffen und Abnahmemengen siehe bitte Preisliste. Konstruktionsänderungen an den Querschnitten vorbehalten - Zur Abklärung der Passgenauigkeit bitte vor Bestellung ein 10cm-Muster anfordern. Lieferung ab Warenwert € 40,- netto frei Haus, ansonsten zzgl. € 6,95 netto Fracht. Maßstab: ca. 1:1. Stand 01/24.

| R 1465 | R 1834 | R 9509 |
|---|---|--|
|  |  |  |

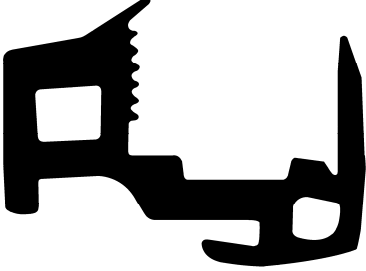
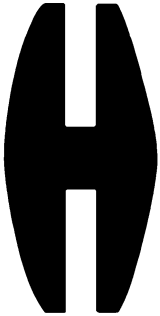

| R 8818 sw | R 5607 | R 5659 sw |
|---|---|---|
|  |  |  |



| R 5636 | R 2208 |
|---|---|
|  |  |

Genauere Angaben zu den Farben, Werkstoffen und Abnahmemengen siehe bitte Preisliste. Konstruktionsänderungen an den Querschnitten vorbehalten - Zur Abklärung der Passgenauigkeit bitte vor Bestellung ein 10cm-Muster anfordern. Lieferung ab Warenwert € 40,- netto frei Haus, ansonsten zzgl. € 6,95 netto Fracht. Maßstab: ca. 1:1. Stand 10/23.



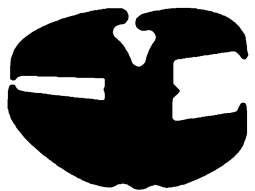

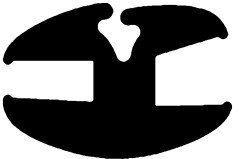
| | | |
|--|--|--|
| R 2201 SW | R 2203 SW | R 2205 SW |
|  1,5mm / 3,0mm / Füller R 2239 |  4,5mm / 5,0mm / Füller R 2239 |  4,0mm / 6,0mm / Füller R 2239 |





| | | |
|--|--|---|
| | | R 2239 SW |
| | |  Füllerprofil |





| | | |
|--|--|--|
| R 2204 SW | R 2206 SW | R 2207 SW |
|  2,0mm / 5,0mm / Füller R 2238 |  2,5mm / 5,0mm / Füller R 2238 |  3,0mm / 8,0mm / Füller R 2238 |

| | | |
|--|--|---|
| R 2202 SW | | R 2238 SW |
|  5,5mm / 6,6mm / Füller R 2238 | |  Füllerprofil |

Genauere Angaben zu den Farben, Werkstoffen und Abnahmemengen siehe bitte Preisliste. Konstruktionsänderungen an den Querschnitten vorbehalten - Zur Abklärung der Passgenauigkeit bitte vor Bestellung ein 10cm-Muster anfordern. Lieferung ab Warenwert € 40,- netto frei Haus, ansonsten zzgl. € 6,95 netto Fracht. Maßstab: ca. 1:1. Stand 04/14.

| | | | | | |
|---|---|---|--|--|---|
| R 100-SK rbr/sw/w | R 102-SK sw/w | R 103-SK sw/w | | | R 105-SK br/w |
|  |  |  | | |  Silikonkautschuk |

| | | | | | |
|---|---|--|--|---|---|
| R 106-SK rbr/sw/w | R 108-SK sw/w | | | R 110-SK br/sw/w | R 111-SK w |
|  |  | | |  Silikonkautschuk |  Silikonkautschuk |

| | | | | | |
|---|---|---|--|---|---|
| R 101-SK br/w | R 107-SK sw | R 109-SK sw | | R 112-SK br/w | R 113-SK br/w |
|  |  |  | |  |  |





| | | | | | |
|--|--|--|--|--|--|
| | | | | | |
| | | | | | |



Genauere Angaben zu den Farben, Werkstoffen und Abnahmemengen siehe bitte Preisliste. Konstruktionsänderungen an den Querschnitten vorbehalten - Zur Abklärung der Passgenauigkeit bitte vor Bestellung ein 10cm-Muster anfordern. Lieferung ab Warenwert € 40,- netto frei Haus, ansonsten zzgl. € 6,95 netto Fracht. Maßstab: ca. 1:1. Stand 12/20.

Sanierungs-dichtungen mit Klebeband – Optimale Haftung auf sauberen Oberflächen

Renovierungs-Dichtungen für Fenster & Türen



| SIT 4-3 br/sw/w | SIT 6-3 br/gr/sw/w | SIT 8-3 br/gr/sw/w | SIT 10-3 br/sw/w | | |
|--|--|--|---|--|--|
|  4mm-Schlauch 3mm Nut |  6mm-Schlauch 3mm Nut |  8mm-Schlauch 3mm Nut |  10mm-Schlauch 3mm Nut | | |

| | SIA 6 br/w | SIA 8 br/w | SIA 10 br/w | | |
|--|---|---|--|--|--|
| |  6mm-Schlauch |  8mm-Schlauch |  10mm-Schlauch | | |

Genauere Angaben zu den Farben, Werkstoffen und Abnahmemengen siehe bitte Preisliste. Konstruktionsänderungen an den Querschnitten vorbehalten - Zur Abklärung der Passgenauigkeit bitte vor Bestellung ein 10cm-Muster anfordern. Lieferung ab Warenwert € 40,- netto frei Haus, ansonsten zzgl. € 6,95 netto Fracht. Maßstab: ca. 1:1. Stand 12/22.